

İÇİNDEKİLER

Kablo Bağları	2-4	Genel Amaçlı Pabuç Sıkma Pensesi	46
Kablo Bağı Aparatları	5-7	Penseseler	46-47-48-49
Baskılı Devre Taşıyıcıları	8	Porselen Sigortalar	50
Dubelli Kablo Tutucular	8	Sigorta Yuvaları	51
İzoleli Yüksükler	10	Hızlı Sigortalar	52
İzolesiz Yüksükler	11	Ölçü Aleti Sigortası	53
İzoleli Çift Giriş Yüksükler	12	Neozet Buşon	53
İzoleli Yuvarlak Kablo Ucu	14	Solar Sigorta Buşonu	53
İzoleli Çatal Kablo Ucu	15	Vita Baskılı Ray Klemensler	54
İzoleli Ekstra Yüksüklü Faston Kablo Ucu	16	Çift Katlı Klemensler	55
Full İzoleli Ekstra Yüksüklü Faston Kablo Ucu	17	Siortalı Ray Klemensler	56
Full İzoleli Ekstra Yük. Polyamid Dişi Faston Kablo Ucu	17	Topraklama Klemensleri	56
İzoleli Ek Mufları	18	Test Klemensi	56
İzoleli Daralan Ek Mufları	18	Üst Köprüler	57
Şeffaf Ek Muflar	18	Yay Baskılı Klemensler	58
İzolesiz Ek Muf	18	İki Katlı Yay Baskılı Klemensler	59
Ekstra Yüksüklü Erkek Geri Dönümlü Dişi Kablo Ucu	19	Üç Katlı Yay Baskılı Klemensler	59
Full İzoleli Ekstra Yük. Erkek Geri Dön. Dişi Kablo Ucu	19	Yay Baskılı Sigortalı Klemens	59
Ucu Kıvrık İzoleli Bıçak Terminaller	20	Dekafixler	60
Bıçak Tip Kablo Ucu	20	Durdurucular	60
İğne Tip Kablo Ucu	20	Klemens İşaretleri ve Etiket Yuvası	60
İzoleli Bayrak Tip Kablo Ucu	21	Mini Yay Baskılı Klemens	61
Full İzoleli Erkek Terminalleri, T Bağlantı Terminalleri	21	Mini Yay Baskılı Topraklı Klemensler	61
İzoleli Ekstra Yüksüklü Yuvarlak Erkek Kablo Ucu	22	Mini Durdurucu ve Sonlandırıcı	61
Full İzoleli Ekstra Yüksüklü Yuvarlak Dişi Kablo Ucu	22	Kablo Kanalları	62
İzoleli Çengel Kablo Ucu	22	Mesnet İzalatörleri (Cam Elyaf)	63
Vidalı Buat Klemensler	23	Cam Elyaf Polyester Tarak İzalatörler	64
Kulaklı Tip Vidalı Buat Klemensler	23	Mesnet İzalatörleri Yanmaz Plastik	65
Kapama Parçası	23	Pana Etiketli Ayağı	66
Açılabilir Buat Klemensleri	24	Pano Topraklama Klemensleri	67-71
Geçmeli Buat Klemensler (Transparan)	24	Bakır Bara Bağlantı Klemensleri	72
Hızlı Kablo Ekleme Parçası	25	Ray ve Ray Taşıyıcılar	73
Panele Kablo Kilitleme Parçası	25	U - C - H Klemensler	74
İzolesiz (Kaynaklı) Kablo Uçları	28-29	Trafo Klemensleri	75
İzolesiz Kaynaklı İğne Tip Kablo Uçları	29	Modül Cihaz Klemensleri	75
SKP Açık Tip Kablo Uçları	29	Steatit Klemensler	75
İzolesiz (Kaynaklı) Çatal Kablo Ucu	30	Mini Klemensler	75
Ek Muflar	30	Sıra Klemensler	76-77
Bimetal SKP (Alüminyum Gövde Bakır Başlık)	30	Pano Etiketleri	78
Ekonomik Tip SKP Kablo Ucu	31	Pano Topraklama Etiketleri (Lobar)	80-95
Dar Girişli SKP Kablo Ucu	31	Flex Baralar	96
Standart Tip SKP Kablo Ucu	32	Dağıtım Baraları (Erico)	97-98
DIN 46235 Normu SKP Kablo Ucu	33	Pano Prizi	99
45° Sıkmalı Kablo Ucu	34	Pano Termostatı	99
90° Sıkmalı Kablo Ucu	35	Pano Isıtıcısı	99
Pirinç Terminaller	36	Proje Cepleri	99
Terminal ve Konnektörler	37	Kabin Fırçası	99
Müşterek ve Otomat Baralar	38	Saç Kenar Fitilleri	99
Nötr Vidalı Topraklama Baraları	38	Kablo Rakorları	99
Modüler Güç Klemensi	38	Pirinç Kablo Rakorları	99
Isı İle Daralan Makaronlar	42	Polyamid Kablo Rakorları	100-101
Renkli Isı İle Daralan Makaronlar	43	Kablo Markalama Cihazları ve Aksesuarları	102-103
İç Yapışkanlı Isı İle Daralan Makaronlar	43	Polyamid Spiral Borular ve Aksesuarları	104-107
Cam Elyaf Makaronlar	44	Sinyal Lambaları ve Aksesuarları	108
H Klas Makaronlar	44	Buton Serisi ve Aksesuarları	109-121
Kablo Toplama Çorabı	45	Buton Kutuları ve Aksesuarları	122-124
HTG Cam Makaronlar	45	Viñç Kumanda Butonları	125
PVC Makaronlar	45	Limit Switchler	126-127
		Sarp Ürünleri ve Ayak Ürünleri	128

KABLO BAĞLARI

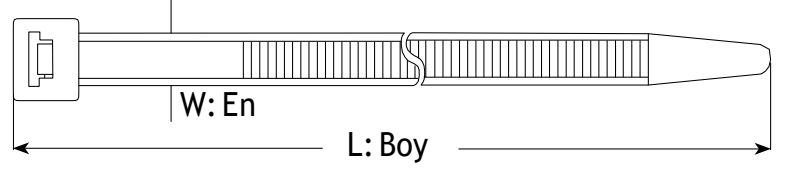

Sipariş Kodu	L	W	Maksimum Bağlama Çapı	Taşıyacağı Ağırlık (Kg)	Poşet Adedi	Koli Adedi
GT-100 M	100	2.5	22	8.1	1.000	80.000
GT-140 M	140	2.5	33	8.1	100	50.000
GT-200 M	200	2.5	53	8.1	100	35.000
GT-150 I	150	3.6	35	18.2	100	30.000
GT-200 I	200	3.6	53	18.2	100	25.000
GT-250 I	250	3.6	65	18.2	100	20.000
GT-300 I	300	3.6	76	18.2	100	20.000
GT-370 I	370	3.6	102	18.2	100	16.000
GT-200 ST	200	4.8	50	22.2	100	17.000
GT-250 ST	250	4.8	60	22.2	100	15.000
GT-300 ST	300	4.8	76	22.2	100	15.000
GT-370 ST	370	4.8	102	22.2	100	12.000
GT-430 ST	430	4.8	110	22.2	100	9.000
GT-530 ST	530	4.8	140	22.2	100	8.000
GT-250 LHD	250	8	60	54.5	100	8.000
GT-300 LHD	300	8	76	54.5	100	6.000
GT-370 LHD	370	8	102	54.5	100	6.000
GT-450 LHD	450	8	127	54.5	100	3.500
GT-530 LHD	530	8	140	54.5	100	3.000
GT-750 LHD	750	8	220	55	100	2.000
GT-760 HD	760	9	236	79.4	100	2.000
GT-940 HD	940	9	280	79.4	100	1.000
GT-1220 HD	1.220	9	365	79.4	100	1.000

* Ürün siparişinde siyah ve beyaz renginde fiyat farkı yoktur.

CT ÜRÜNLERİ DUPONT Marka, Nylon 6/6 hammaddesinden imal edilmiş olup, -40, +85 °C ortam sıcaklığında çalışır. UL 94/V2 normunda, kendini söndürme özelliğine sahiptir. YÜKSEK kaliteli CT kablo bağları (Benzin, mazot, hayvansal yağ, boya, vernik) gibi maddelere karşı ÜSTÜN direnç göstermektedir. ÜRÜNÜN siyah renkleri stok olarak mevcuttur.

RENKLİ KABLO BAĞLARI

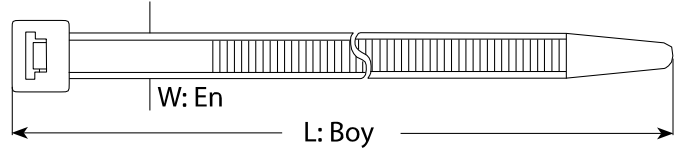
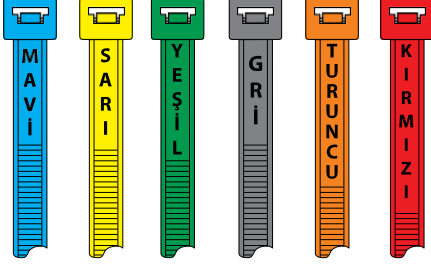

* Yandaki standart renklerin dışındaki renk istekleriniz ithal edilebilir.

Sipariş Kodu	L	W	Maksimum Bağlama Çapı	Taşıyacağı Ağırlık (Kg)	Poşet Adedi	Koli Adedi
GT-100 M	100	2.5	22	8.1	1.000	80.000
GT-140 M	140	2.5	40	8.1	100	50.000
GT-200 M	200	2.5	53	8.1	100	35.000
GT-150 I	150	3.6	35	18.2	100	30.000
GT-200 I	200	3.6	53	18.2	100	25.000
GT-250 I	250	3.6	65	18.2	100	20.000
GT-300 I	300	3.6	76	18.2	100	20.000
GT-200 ST	200	4.8	50	22.2	100	17.000
GT-250 ST	250	4.8	102	22.2	100	15.000
GT-300 ST	300	4.8	76	22.2	100	15.000
GT-370 ST	370	4.8	102	22.2	100	12.000
GT-370 LHD	370	8	102	54.5	100	6.000
GT-450 LHD	450	8	127	54.5	100	3.500
GT-530 LHD	530	8	140	54.5	100	3.000

ULTRAVİYOLE (UV) KABLO BAĞLARI



Sipariş Kodu	L	W	Maksimum Bağlama Çapı	Taşıyacağı Ağırlık (Kg)	Poşet Adedi	Koli Adedi
GT-100 M UV	100	2.5	22	8.1	1.000	80.000
GT-140 M UV	140	2.5	33	8.1	100	50.000
GT-200 M UV	200	2.5	53	8.1	100	35.000
GT-150 I UV	150	3.6	35	18.2	100	30.000
GT-200 I UV	200	3.6	53	18.2	100	25.000
GT-250 I UV	250	3.6	65	18.2	100	20.000
GT-300 I UV	300	3.6	76	18.2	100	20.000
GT-370 I UV	370	3.6	102	18.2	100	20.000
GT-200 ST UV	200	4.8	50	22.2	100	17.000
GT-250 ST UV	250	4.8	60	22.2	100	15.000
GT-300 ST UV	300	4.8	76	22.2	100	15.000
GT-370 ST UV	370	4.8	102	22.2	100	12.000
GT-300 LHD UV	300	8	76	54.5	100	6.000
GT-370 LHD UV	370	8	102	54.5	100	6.000
GT-450 LHD UV	450	8	127	54.5	100	3.500
GT-530 LHD UV	530	8	140	54.5	100	3.000
GT-760 HD UV	760	9	236	79.4	100	2.000
GT-940 HD UV	940	9	280	79.4	100	1.000

PASLANMAZ ÇELİK KABLO BAĞLARI

AISI 304 - 316
Paslanmaz Çelik

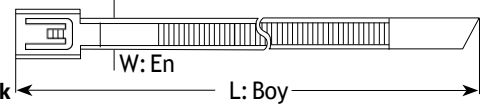

Sipariş Kodu	L	W	Maksimum Bağlama Çapı	Taşıyacağı Ağırlık (Kg)	Poşet Adedi	Koli Adedi
TME-127 STC	127	4.6	15	55	100	8.000
GTME-152 STC	152	4.6	44	55	100	8.000
GTME-201 STC	201	4.6	51	55	100	6.000
GTME-266 STC	266	4.6	69	55	100	6.000
GTME-300 STC	300	4.6	76	55	100	4.000
GTME-362 STC	362	4.6	102	55	100	4.000
GTME-521 STC	521	4.6	152	55	100	3.000
GTME-679 STC	679	4.6	203	55	100	2.000
GTME-838 STC	838	4.6	254	55	100	2.000
GTME-152 HDC	152	7.9	44	120	100	4.000
GTME-201 HDC	201	7.9	51	120	100	3.000
GTME-266 HDC	266	7.9	69	120	100	2.000
GTME-300 HDC	300	7.9	76	120	100	2.000
GTME-362 HDC	362	7.9	102	120	100	1.500
GTME-521 HDC	521	7.9	152	120	100	1.500
GTME-679 HDC	679	7.9	203	120	100	1.000
GTME-838 HDC	838	7.9	254	120	100	1.000

PVC KAPLI ÇELİK KABLO BAĞLARI



Sipariş Kodu	L	W	Max. Bağlama Çapı	Taşıyacağı Ağırlık (Kg)	Poşet Adedi	Koli Adedi
TME-PVC-127 ST	127	4.6	15	55	100	8.000
GTME-PVC-152 ST	152	4.6	44	55	100	8.000
GTME-PVC-201 ST	201	4.6	51	55	100	6.000
GTME-PVC-266 ST	266	4.6	69	55	100	6.000
GTME-PVC-300 ST	300	4.6	76	55	100	4.000
GTME-PVC-362 ST	362	4.6	102	55	100	4.000
GTME-PVC-521 ST	521	4.6	152	55	100	3.000
GTME-PVC-679 ST	679	4.6	203	55	100	2.000
GTME-PVC-838 ST	838	4.6	254	55	100	2.000
GTME-PVC-152 HD	152	7.9	44	120	100	4.000
GTME-PVC-201 HD	201	7.9	51	120	100	3.000
GTME-PVC-266 HD	266	7.9	69	120	100	3.000
GTME-PVC-300 HD	300	7.9	76	120	100	2.000
GTME-PVC-362 HD	362	7.9	102	120	100	1.500
GTME-PVC-521 HD	521	7.9	152	120	100	1.500
GTME-PVC-679 HD	679	7.9	203	120	100	2.000
GTME-PVC-838 HD	838	7.9	254	120	100	1.000

PASLANMAZ ÇELİK ETİKET



Sipariş Kodu	Boy ve Genişlik (mm)	Poşet Adedi
GTME- ETK	19 x 90	100

BÜKÜLEBİLİR KLİPS

Ölçüler (mm)	TH-D	TH-E	TH-F	TH-G	TH-H	TH-I	TH-J	TH-K	TH-L
ØA	11.2	5.2	8.3	11.5	15	18	19.5	22.5	5.2
B	28.4	21	25.2	30.9	35.1	40	42.5	45.5	22
Bağlama Çapı	10.2	4.5	7.3	10.5	14	17	19	22	5
Poşet Adedi	1.000	1.000	1.000	1.000	1.000	1.000	1.000	1.000	1.000

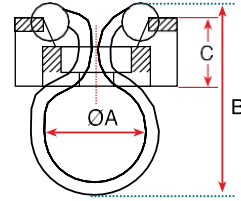

VIDALI KROŞELER

Sipariş Kodu	A	B	C	D	E	Max. Bağlama Genişliği	Poşet Adedi
GSM - 2	17	10	6.5	3.7	6.5	4.8	250
GSM - 3	23	17	9.5	6.4	12.5	8	250
GSM - 5	30	15	11.7	4.8	-	8	100

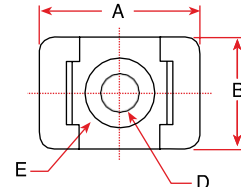

GSM - 5

TABANI YAPIŞKANLI KANCALI KLİPS

Sipariş Kodu	A	B	C	D	Max. Bağlama Genişliği (E)	Poşet Adedi
CT-05	25	25	12.7	12.5	8	100
CT-07	25	25	12.7	16.5	12	100

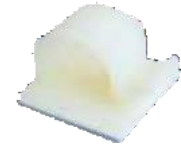
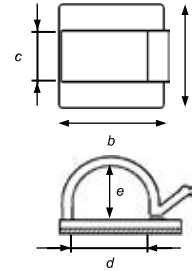

CT-07



TABANI YAPIŞKANLI BÜKÜLEBİLİR KLİPS

Sipariş Kodu	A	B	C	Max. Bağlama Çapı	Poşet Adedi
HW - 8 Ab	20x20	32	16	14	100

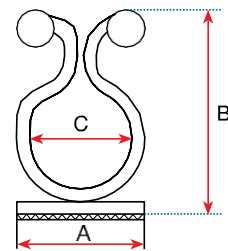

Sipariş Kodu	En	Boy	Poşet Adedi	Koli Adedi
KBET1	35	10	100	12.500
KBET2	45	20	100	6.000



KABLO BAĞLI ETİKET TAŞIYICI

KABLO SIKIŞTIRICI

Sipariş Kodu	Ø	Ø'	A	B	C	D	Poşet Adedi
GCL - 1/8S	3.6	3.3	8.2	9.1	1.27	M 5	100
GCL - 3/16S	5.3	4.8	9.6	9.1	1.27	M 5	
GCL - 1/4S	7.4	6.6	10.3	9.1	1.27	M 5	
GCL - 5/16S	8.9	7.8	10.6	9.1	1.27	M 5	
GCL - 3/8S	10.9	9.7	11.9	9.2	1.27	M 5	
GCL - 1/2	12.7	12.2	15	12.7	1.50	M 5	
GCL - 5/8	34.3	32.6	15.8	15.8	1.50	M 5	
GCL - 3/8	9.5	9.1	13.4	12.7	1.50	M 5	
GCL - 1/2	12.7	12.2	15	12.7	1.50	M 5	
GCL - 9/16	14.2	13.8	15.8	12.7	1.50	M 5	
GCL - 3/4	19	18.6	19.8	12.7	1.50	M 5	
GCL - 7/8	22.2	21.8	21.4	12.7	1.50	M 5	

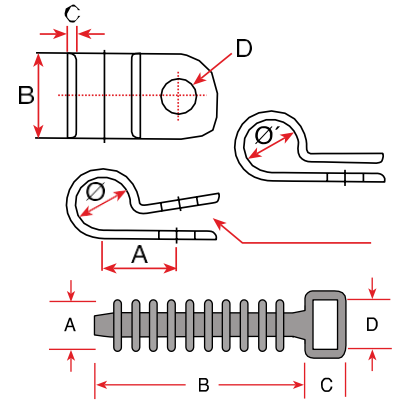

BETON KROŞE

Sipariş Kodu	A	B	C	D	Max. Bağlama Genişliği	Poşet Adedi
GW-52210	9.5	36	6	9.5	9.5	100



FLAT KABLOTUTUCU

Sipariş Kodu	A	B	H	Poşet Adedi
FC-15	15	26	6.5	100
FC-25	25	26	10	

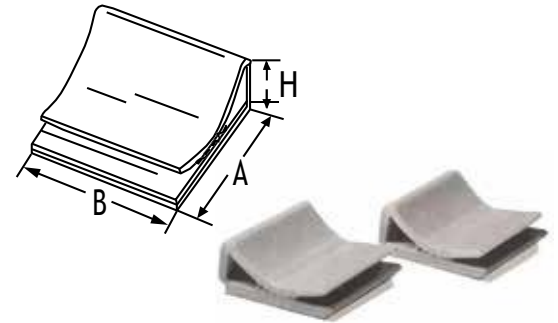

DÜŞÜK PROFİL TUTUCUSU

Sipariş Kodu	A	B	C	D	Max. Bağlama Genişliği	Poşet Adedi
GLM - 3	19.1	12.7	3.4	4.5	4.8	100

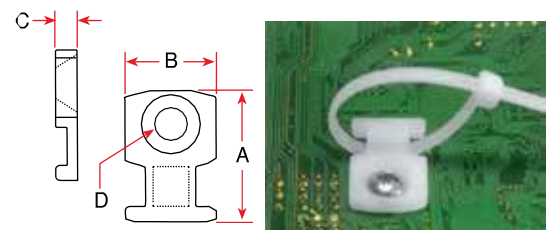

BASKILI DEVRE TAŞIYICILARI

Sipariş Kodu	A	Poşet Adedi
CBS - 6 A	6.2	1.000
CBS - 9 A	9.2	
CBS - 13 A	12.6	
CBS - 16 A	15.8	
CBS - 19 A	19.1	
CBS - 25 A	25.1	

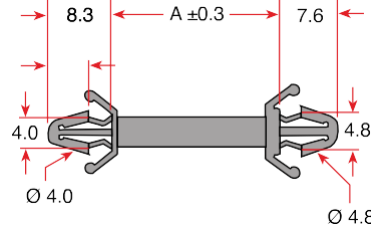

TERS KİLİTLEMELİ BASKILI DEVRE TAŞIYICILARI

Sipariş Kodu	A	Poşet Adedi
WMB - 5	5	1.000
WMB - 8	8	
WMB - 10	10	
WMB - 12	12	
WMB - 14	14	
WMB - 19	19	

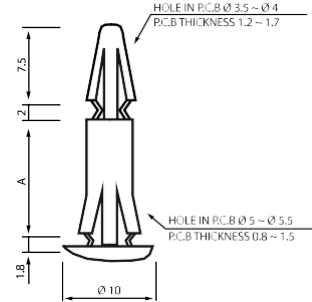

DUBELLİ KABLO TUTUCULAR (Delik Çapı Ø 4.8 mm)

Sipariş Kodu	Yükseklik	Genişlik	A	B	Poşet Adedi
CT-10	21.7 mm	15.3 mm	11.3 mm	6 mm	1.000
CT-27	27.3 mm	15.2 mm	11.2 mm	9.8 mm	
CT-28	36.3 mm	15.2 mm	11.2 mm	19 mm	
CT-18	22 mm	15.5 mm	11.6 mm	7 mm	
CT-24	20.3 mm	20 mm	8 mm	8 mm	

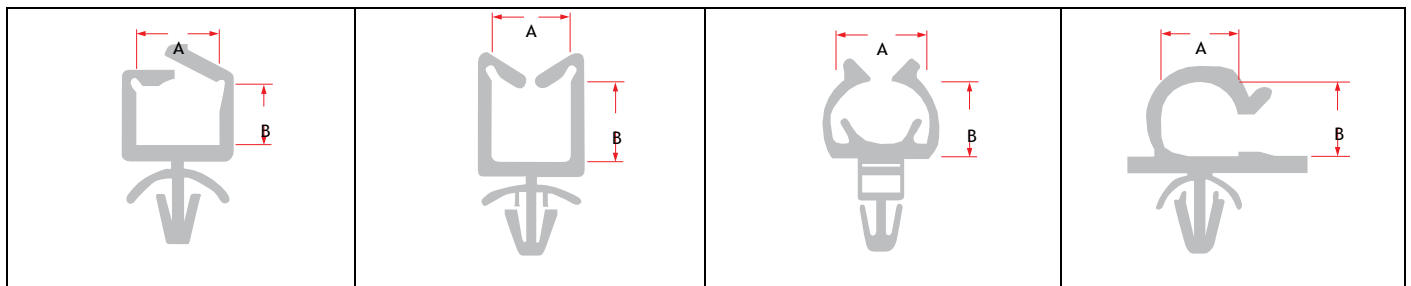
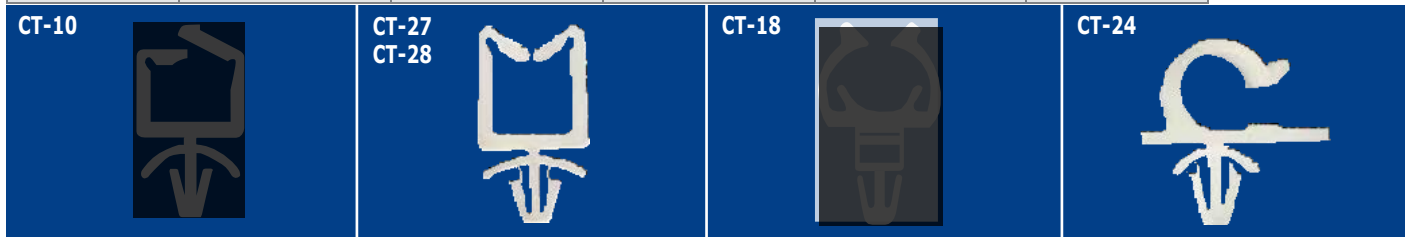

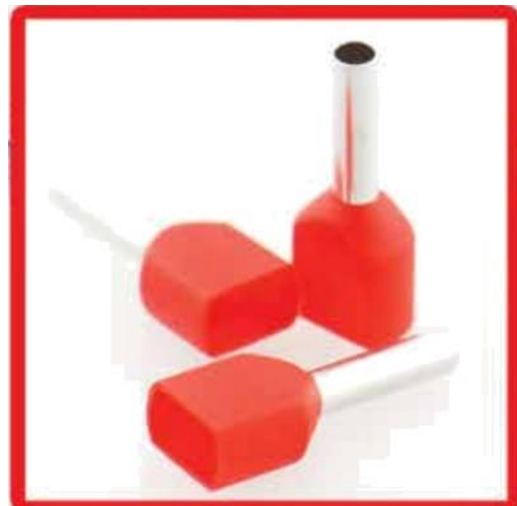





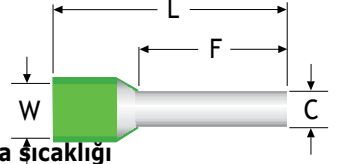















































İZOLELİ YÜKSÜKLER

DIN 46228 standardı, bakır malzemeden kalay kaplı, polyamid izoleli, -40 °C- +105 °C çalışma sıcaklığı



RENK NORMLARI		
FRANSIZ	ALMAN	DIN
	 gri	
 mor	 turkuaz	
 pembe	 turkuaz	
 beyaz	 turuncu	 beyaz
 mavi	 beyaz	 gri
 kırmızı	 sarı	 kırmızı
 siyah	 kırmızı	 siyah
 gri	 mavi	 mavi
 turuncu	 gri	 gri
 yeşil	 siyah	 sarı
 kahve	 bej	 kırmızı
 bej	 yeşil	 mavi
 siyah	 kahve	 sarı
 kırmızı	 bej	 kırmızı
 mavi	 nefti	 mavi
 sarı	 sarı	 sarı
 kırmızı	 kırmızı	 kırmızı
 mavi	 mavi	 mavi
 sarı	 sarı	 sarı

Sipariş Kodu	Kablo Kesiti	F	L	C	W	Kutu Adedi	t
LT-001406	0.14 mm ²	6.0	10.0	0.70	1.6	1.000	
LT-001408		8.0	12.0	0.70	1.6	1.000	
LT-002506	0.25 mm ²	6.0	10.0	0.75	1.9	1.000	
LT-002508		8.0	12.0	0.75	1.9	1.000	
LT-003406	0.34 mm ²	6.0	10.0	0.80	1.9	1.000	
LT-003408		8.0	12.0	0.80	1.9	1.000	
LT-005006	0.50 mm ²	6.0	12.0	1.00	2.6	1.000	
LT-005008		8.0	14.0	1.00	2.6	1.000	
LT-005010		10.0	16.0	1.00	2.6	1.000	
LT-007506	0.75 mm ²	6.0	12.0	1.20	2.8	1.000	
LT-007508		8.0	14.0	1.20	2.8	1.000	
LT-007510		10.0	16.0	1.20	2.8	1.000	
LT-007512		12.0	18.0	1.20	2.8	1.000	
LT-010006	1.00 mm ²	6.0	12.0	1.40	3.0	1.000	
LT-010008		8.0	14.0	1.40	3.0	1.000	
LT-010010		10.0	16.0	1.40	3.0	1.000	
LT-010012		12.0	18.0	1.40	3.0	1.000	
LT-015008	1.50 mm ²	8.0	14.0	1.70	3.5	500	
LT-015010		10.0	16.0	1.70	3.5	500	
LT-015012		12.0	18.0	1.70	3.5	500	
LT-015018		18.0	24.0	1.70	3.5	500	
LT-025008	2.50 mm ²	8.0	14.0	2.20	4.2	500	
LT-025010		10.0	16.0	2.20	4.2	500	
LT-025012		12.0	18.0	2.20	4.2	500	
LT-025018		18.0	24.0	2.20	4.2	250	
LT-040010	4.00 mm ²	10.0	17.0	2.80	4.8	250	
LT-040012		12.0	20.0	2.80	4.8	250	
LT-040018		18.0	26.0	2.80	4.8	250	
LT-060012	6.00 mm ²	12.0	20.0	3.50	6.3	200	
LT-060018		18.0	26.0	3.50	6.3	200	
LT-100012	10 mm ²	12.0	22.0	4.50	7.6	100	
LT-100018		18.0	28.0	4.50	7.6	100	
LT-160012	16 mm ²	12.0	24.0	5.80	8.8	100	
LT-160018		18.0	28.0	5.80	8.8	100	
LT-250016	25 mm ²	16.0	30.0	7.30	11.2	100	
LT-250018		18.0	32.0	7.30	11.2	100	
LT-250022		22.0	36.0	7.30	11.2	100	
LT-350016	35 mm ²	16.0	30.0	8.30	12.7	100	
LT-350018		18.0	32.0	8.30	12.7	100	
LT-350022		22.0	37.0	8.30	12.7	100	
LT-350025		25.0	39.0	8.30	12.7	100	
LT-500020	50 mm ²	20.0	36.0	10.30	15.0	100	
LT-500025		25.0	40.0	10.30	15.0	100	
LT-700021	70 mm ²	21.0	37.0	13.50	16.0	100	
LT-950025	95 mm ²	25.0	44.0	14.70	18.0	100	
LT-120027	120 mm ²	27.0	48.0	16.70	20.0	100	
LT-150032	150 mm ²	32.0	58.0	19.50	23.0	100	

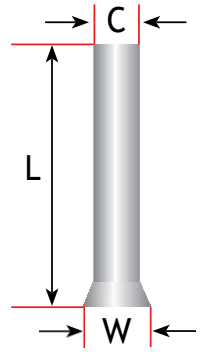

İZOLESİZ YÜKSÜKLER









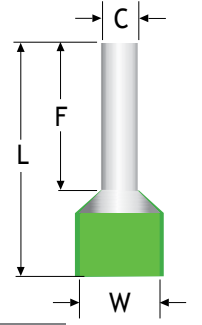

















DIN 46228 standardı, bakır malzemeden kalay kaplı

Sipariş Kodu	Kablo Kesiti	Ölçüler			Ambalaj Adedi
		L	C	W	
CN-005006	0.50 mm ²	6.0	1.0	2.1	1.000
CN-005008		8.0			1.000
CN-005010		10.0			1.000
CN-075006	0.75 mm ²	6.0	1.2	2.3	1.000
CN-075008		8.0			1.000
CN-075010		10.0			1.000
CN-010008	1.0 mm ²	8.0	1.4	2.5	1.000
CN-010010		10.0			1.000
CN-010012		12.0			1.000
CN-015008	1.5 mm ²	8.0	1.7	2.8	1.000
CN-015010		10.0			1.000
CN-015012		12.0			1.000
CN-025008	2.5 mm ²	8.0	2.2	3.4	1.000
CN-025010		10.0			1.000
CN-025012		12.0			1.000
CN-040008	4.0 mm ²	8.0	2.8	4.0	500
CN-040010		10.0			500
CN-040012		12.0			500
CN-040015		15.0			500
CN-040018		18.0			500
CN-060010	6.0 mm ²	10.0	3.5	4.7	250
CN-060012		12.0			250
CN-060015		15.0			250
CN-060018		18.0			250
CN-100012	10.0 mm ²	12.0	4.5	5.8	200
CN-100015		15.0			200
CN-100018		18.0			200
CN-160012	16.0 mm ²	12.0	5.8	7.5	200
CN-160015		15.0			200
CN-160018		18.0			200
CN-250015	25.0 mm ²	15.0	7.3	9.5	100
CN-250016		16.0			100
CN-250018		18.0			100
CN-250022		22.0			100
CN-350016	35.0 mm ²	16.0	8.3	11.0	100
CN-350018		18.0			100
CN-350020		20.0			100
CN-350025		25.0			100
CN-500018	50.0 mm ²	18.0	10.3	13.0	100
CN-500020		20.0			100
CN-500022		22.0			100
CN-500025		25.0			100
CN-700025	70.0 mm ²	25.0	13.5	15.3	100
CN-950025	95.0 mm ²	25.0	14.7	16.6	100
CN-120032	120.0 mm ²	32.0	16.7	18.0	100
CN-150022	150.0 mm ²	22.0	19.5	21.5	100

İZOLELİ ÇİFT GİRİŞLİ YÜKSÜKLER

DIN 46228 standardı, bakır malzemeden kalay kaplı, polyamid izoleli, -40 °C- +105 °C çalışma sıcaklığı



RENK NORMLARI		
FRANSIZ	ALMAN	DIN
 beyaz	 turuncu	 beyaz
 mavi	 beyaz	 gri
 kırmızı	 sarı	 kırmızı
 siyah	 kırmızı	 siyah
 gri	 mavi	 mavi
 turuncu	 gri	 gri
 yeşil	 siyah	 sarı
 kahve	 bej	 kırmızı
 bej	 yeşil	 mavi

Sipariş Kodu	Kablo Kesiti	F	L	C	W	Kutu Adedi
CT - 205008	2 x 0.50 mm ²	8.0	15.0	1.5	2.5 / 4.7	500
CT - 207508	2 x 0.75 mm ²	8.0	15.0	1.8	2.8 / 5.0	500
CT - 207510		10.0	17.0	1.8	2.8 / 5.0	500
CT - 210008	2 x 1.0 mm ²	8.0	15.0	2.05	3.4 / 5.4	500
CT - 210010		10.0	17.0	2.05	3.4 / 5.4	500
CT - 215008	2 x 1.5 mm ²	8.0	16.0	2.3	3.6 / 6.6	500
CT - 215010		10.0	18.0	2.3	3.6 / 6.6	500
CT - 215012		12.0	20.0	2.3	3.6 / 6.6	250
CT - 225010	2 x 2.5 mm ²	10.0	18.5	2.8	4.2 / 7.8	250
CT - 225013		13.0	21.5	2.8	4.2 / 7.8	250
CT - 240012	2 x 4.0 mm ²	12.0	23.0	3.7	4.9 / 8.8	100
CT - 260014	2 x 6.0 mm ²	14.0	26.0	4.8	6.9 / 10.0	100
CT - 210014	2 x 10.0 mm ²	14.0	26.5	6.4	7.6 / 12.8	100
CT - 216014	2 x 16.0 mm ²	14.0	31.5	8.3	9.6 / 18.6	100





JEE SOON TERMINALS
A BRIDGE TO SUCCESS





İZOLELİ YUVARLAK KABLO UCU

DIN 46237 standardı, bakır malzemeden kalay kaplı, PVC izoleli, +105 °C çalışma sıcaklığı, 600 volt enerji dayanabilme özelliğine sahiptir.

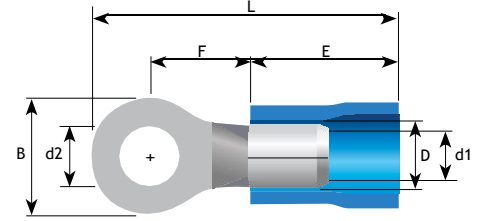
Not: Extra bakır yüksüklü ürünler stoklarımızda mevcuttur.



Sipariş Kodu	Kablo Kesitleri	Metrik Ölç. (d2)	Ölçüler (mm)					Renkler	Kutu Adedi	
			B	F	L	E	D			d1
R1-3 V	0.5 - 1.5 mm ² 22 - 16 AWG	3.2	5.5	4.0	16.7	10.0	4.1	1.7		200
R1-3.5 MV		3.7	6.6	6.3	19.6					200
R1-4 SV		4.3	6.6	6.3	19.6					200
R1-4 LV		4.3	8.0	7.0	21.0					200
R1-5 V		5.3	8.0	7.0	21.0					200
R1-6 V		6.5	11.6	11.1	26.8					200
R1-8 V		8.4	11.6	11.1	26.8					200
R1-10 V		10.5	13.6	13.9	30.7					100
R1-12 V		13	19.2	16.0	35.6					100

R2-3 V	1.5 - 2.5 mm ² 16 - 14 AWG	3.2	6.4	4.3	17.5	10.0	4.5	2.3		200
R2-3.5 MV		3.7	6.6	6.3	19.5					200
R2-3.5 LV		3.7	8.5	7.8	22.0					200
R2-4 SV		4.3	6.6	6.3	19.6					200
R2-4 LV		4.3	8.5	7.8	22.0					200
R2-5 SV		5.3	8.5	7.8	22.0					200
R2-5 LV		5.3	9.5	7.3	22.0					200
R2-6 V		6.5	12.0	11.0	27.0					200
R2-8 V		8.4	12.0	11.0	27.0					200
R2-10 V		10.5	13.6	13.9	30.7					100
R2-12 V		13.0	19.2	16.0	35.6					100

R5-4 SV	4.0 - 6.0 mm ² 12 - 10 AWG	4.3	7.2	5.9	22.0	12.5	6.5	3.4		100
R5-4 LV		4.3	9.5	8.3	25.5					100
R5-5 V		5.3	9.5	8.3	25.5					100
R5-6 V		6.5	12.0	10.5	29.0					100
R5-8 V		8.4	15.0	13.7	33.7					100
R5-10 V		10.5	15.0	13.7	33.7					100
R5-12 V		13.0	19.2	16.0	38.1					100

R8-4 LV	8.0 - 10.0 mm ² 8 AWG	4.3	12.0	9.7	32.5	17.0	8.0	4.5		100
R8-5 MV		5.3	12.0	9.7	32.5					100
R8-5 LV		5.3	12.0	13.8	38.0					100
R8-6 SV		6.7	12.0	9.7	32.5					100
R8-6 LV		6.7	15.0	13.8	38.0					100
R8-8 V		8.4	15.0	13.8	38.0					100
R8-10 V		10.5	15.0	13.8	38.0					100

İZOLELİ ÇATAL KABLO UCU

DIN 46237 standardı, bakır malzemeden kalay kaplı, PVC izoleli, 105 °C çalışma sıcaklığı, 600 Volt enerji dayanabilme özelliğine sahiptir.

Not: Extra bakır yüksüklü ürünler stoklarımızda mevcuttur.

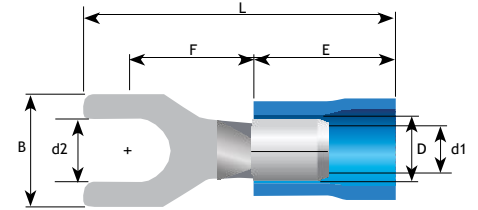

Sipariş Kodu	Kablo Kesitleri	Metrik Ölç. (d2)	Ölçüler (mm)						Renkler	Kutu Adedi
			B	F	L	E	D	d1		
S1-3 V	0.5 ~ 1.5 mm ² 22 ~ 16 AWG	3.2	5.8	6.3	21.0	10.0	4.1	1.7		200
S1-3.5 SV		3.7	6.4	6.3	20.6					200
S1-3.5 LV		3.7	7.2	6.3	21.0					200
S1-4 SV		4.3	6.4	6.3	20.6					200
S1-4 MV		4.3	7.2	6.3	21.0					200
S1-5 SV		5.3	8.0	7.0	21.0					200
S1-5 LV		5.3	9.5	7.0	21.0					200
S1-6 LV		6.5	12.0	11.0	27.2					200
S1-8 V		8.4	12.0	11.0	27.2					100

S2-3 V	1.5 ~ 2.5 mm ² 16 ~ 14 AWG	3.2	5.8	6.3	21.0	10.0	4.5	2.3		200
S2-3.5 MV		3.7	6.4	6.3	21.0					200
S2-4 SV		4.3	6.4	6.3	21.0					200
S2-4 MV		4.3	7.2	6.5	21.2					200
S2-5 LV		5.3	9.5	7.2	22.0					200
S2-6 LV		6.5	12.0	11.0	27.2					200
S2-8 V		8.4	12.0	11.0	27.2					100

S5-3.5 SV	4.0 ~ 6.0 mm ² 12 ~ 10 AWG	3.7	7.2	7.5	25.2	12.5	6.5	3.4		100
S5-4 SV		4.3	8.5	7.5	25.2					100
S5-4 LV		4.3	9.5	7.5	25.2					100
S5-5 V		5.3	9.5	7.5	25.2					100
S5-6 SV		6.5	9.5	7.5	25.2					100
S5-6 LV		6.5	12.0	12.0	31.2					100
S5-8 V		8.4	13.5	10.5	30.0					100

S8-4 V	8.0 - 10.0 mm ² 8 AWG	4.3	8.2	8.1	29.0	17.0	8.0	4.5		100
S8-5 V		5.3	9.0	8.1	29.0					100
S8-6 V		6.5	10.8	8.6	30.5					100

İZOLELİ EKSTRA YÜKSÜKLÜ FASTON KABLO UCU

Pirinç malzemeden kalay kaplı, PVC izoleli, 75°C çalışma sıcaklığı, 300Volt enerjiye dayanabilme özelliğine sahiptir.

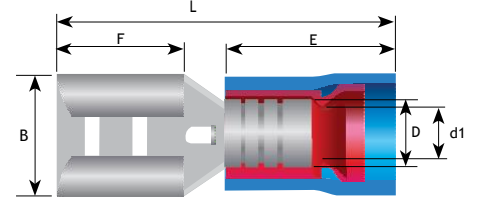

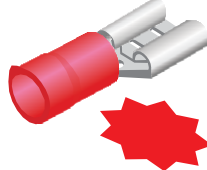
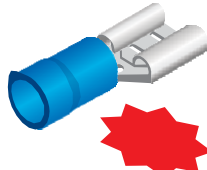
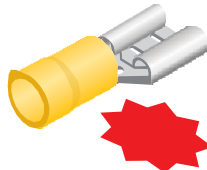

Sipariş Kodu	Kablo Kesitleri	Soket Genişliği	Ölçüler (mm)						Renkler	Kutu Adedi
			B	F	L	E	D	d1		
F1-2.8 VD/5	0.5 - 1.5 mm ² 22 - 16 AWG	0.5 x 2.8	3.2	6.4	18.5	10.0	4.3	1.7		200
F1-2.8 VD/8		0.8 x 2.8	3.2	6.4	18.5					200
F1-4.8 VD/5		0.5 x 4.8	5.0	6.5	19.0					200
F1-4.8 VD/8		0.8 x 4.8	5.0	6.5	19.0					200
F1-6.4 VD		0.8 x 6.4	6.6	7.9	21.0					200
F1-8 VD		0.8 x 8.0	8.4	10.0	24.0					200
F2-2.8 VD/5	1.5 - 2.5 mm ² 16 - 14 AWG	0.5 x 2.8	3.2	6.4	18.5	10.0	5.0	2.3		200
F2-2.8 VD/8		0.8 x 2.8	3.2	6.4	18.5					200
F2-4.8 VD/5		0.5 x 4.8	5.0	6.5	19.0					200
F2-4.8 VD/8		0.8 x 4.8	5.0	6.5	19.0					200
F2-6.4 VD		0.8 x 6.4	6.6	7.9	21.0					200
F2-8 VD		0.8 x 8.0	8.4	10.0	24.0					200
F2-9.5 VD	1.2 x 9.5	9.5	12.5	29.0	100					
F5-6.4 VD	4.0 - 6.0 mm ² 12 - 10 AWG	0.8 x 6.4	6.6	7.9	23.5	12.5	6.5	3.4		100
F5-9.5VD		1.2 x 9.5	9.9	12.5	28.5					100

FULL İZOLELİ EKSTRA YÜKSÜKLÜ FASTON KABLO UCU

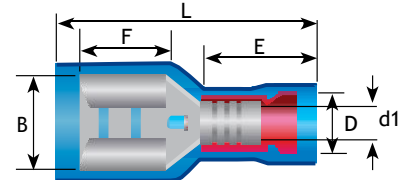
Pirinç malzemeden kalay kaplı, PVC izoleli, 75°C çalışma sıcaklığı, 300Volt enerjiye dayanabilme özelliğine sahiptir.





Sipariş Kodu	Kablo Kesitleri	Soket Genişliği	Ölçüler (mm)						Renkler	Kutu Adedi
			B	F	L	E	D	d1		
F1-2.8 VFD/5	0.5 - 1.5 mm ² 22 - 16 AWG	0.5 x 2.8	3.2	6.4	19.0	10.0	4.3	1.7		200
F1-2.8 VFD/8		0.8 x 2.8	3.2	6.4	19.0					200
F1-4.8 VFD/5		0.5 x 4.8	5.0	6.5	20.0					200
F1-4.8 VFD/8		0.8 x 4.8	5.0	6.5	20.0					200
F1-6.4 VFD		0.8 x 6.4	6.6	7.9	22.0					200
F2-2.8 VFD/5	1.5 - 2.5 mm ² 16 - 14 AWG	0.5 x 2.8	3.2	6.4	19.0	10.0	5.0	2.3		200
F2-2.8 VFD/8		0.8 x 2.8	3.2	6.4	19.0					200
F2-4.8 VFD/5		0.5 x 4.8	5.0	6.5	20.0					200
F2-4.8 VFD/8		0.8 x 4.8	5.0	6.5	20.0					200
F2-6.4 VFD		0.8 x 6.4	6.6	7.9	22.0					100
F5-6.4 VFD	4.0 - 6.0 mm ² 12 - 10 AWG	0.8 x 6.4	6.6	7.9	25.0	13.0	6.5	3.4		100

FULL İZOLELİ EKSTRA YÜKSÜKLÜ POLYAMİD DİŞİ FASTON KABLO UCU

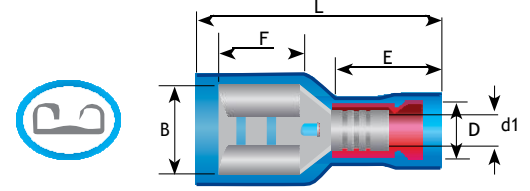
Pirinç malzemeden kalay kaplı, polyamid izoleli, 105°C çalışma sıcaklığı, 300 Volt enerjiye dayanabilme özelliğine sahiptir.

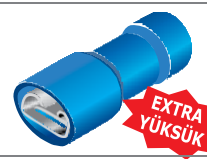



Sipariş Kodu	Kablo Kesitleri	Soket Genişliği	Ölçüler (mm)						Renkler	Kutu Adedi
			B	F	L	E	D	d1		
F1 - 2.8 AFC	0.5 - 1.5 mm 22 - 16 AWG	0.8 x 2.8	2.8	19.0	10.5	4.2	1.7	1.7		100
F1 - 6.4 AFC		0.8 x 6.4	6.4	22.0	10.5	4.2	1.7	1.7		100
F2 - 6.4 AFC	1.5 - 2.5 mm 16 - 14 AWG	0.8 x 6.4	6.4	7.9	22.0	10.5	4.9	2.3		100
F5 - 6.4 AFC	4.0 - 6.0 mm 12 - 10 AWG	0.8 x 6.4	6.4	24.5	13.0	6.5	3.4	3.4		100

EKSTRA YÜKSÜKLÜ ERKEK GERİ DÖNÜŞLÜ DİŞİ KABLO UCU

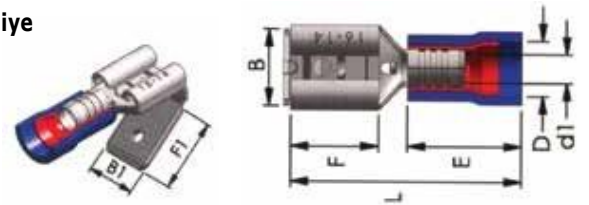
Pirinç malzemeden kalay kaplı, PVC izoleli, 75°C çalışma sıcaklığı, 300 Volt enerjiye dayanabilme özelliğine sahiptir.





Sipariş Kodu	Kablo Kesitleri	Soket Genişliği	Ölçüler (mm)								Renkler	Kutu Adedi
			B	B1	F	F1	L	E	D	d1		
PB1 - 6.4 VD	0.5 - 1.5 mm 22 - 16 AWG	0.8 x 6.4	6.6	6.4	8.0	8.2	21.0	10.0	4.3	1.7		100
PB2 - 6.4 VD			6.6	6.4	8.0	8.2	21.0	10.0	5.0	2.3		
PB5 - 6.4 VD	4.0 - 6.0 mm 12 - 10 AWG	0.8 x 6.4	6.6	6.4	8.0	8.2	23.5	12.5	6.5	3.4		100

İZOLELİ EK MUFLARI

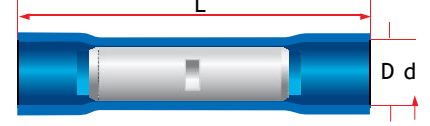
Pirinç malzemeden kalay kaplı, PVC izoleli, 75°C çalışma sıcaklığı, 300 Volt enerjiye dayanabilme özelliğine sahiptir.





Sipariş Kodu	Kablo Kesitleri	Ölçüler (mm)			Renkler	Kutu Adedi
		L	D	d1		
BB 1V	0.5 - 1.5 mm ² 22 - 16 AWG	26.0	4.1	1.7		200
BB 2V	1.5 - 2.5 mm ² 16 - 14 AWG	26.0	4.5	2.3		200
BB 5V	4.0 - 6.0 mm ² 12 - 10 AWG	26.0	6.5	3.4		200

ŞEFFAF İZOLELİ DARALAN MAKARONLU EK MUF

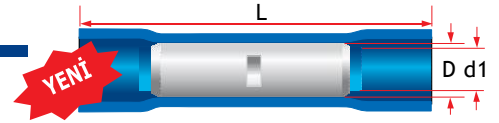
Pirinç malzemeden kalay kaplı, PVC izoleli, 75°C çalışma sıcaklığı, 300 Volt enerjiye dayanabilme özelliğine sahiptir.





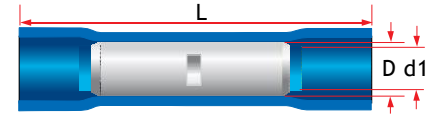

Sipariş Kodu	Kablo Kesitleri	Ölçüler (mm)			Renkler	Kutu Adedi
		L	D	d1		
BCT1H	0.5 - 1.5 mm ² 22 - 16 AWG	24.0	1.6	0.75		200
BCT2H	1.5 - 2.5 mm ² 16 - 14 AWG	37.0	2.3	0.8		200
BCT5H	4 - 6 mm ² 12 - 10 AWG	41.0	3.6	0.9		200

POLYAMİD ŞEFFAF EK MUFLARI

Bakır malzemeden kalay kaplı, polyamid izoleli, 105°C çalışma sıcaklığı, 600 Volt enerjiye dayanabilme özelliğine sahiptir.



Sipariş Kodu	Kablo Kesitleri	Ölçüler (mm)			Renkler	Kutu Adedi
		L	D	d1		
BC 0.5A	0.2 - 0.5 mm ² 26 - 22 AWG	20.0	2.3	1.0		200
BC 1A	0.5 - 1.5 mm ² 22 - 16 AWG	26.0	4.2	1.8		200
BC 2A	1.5 - 2.5 mm ² 16 - 14 AWG	26.0	4.8	2.4		100
BC 5A	4.0 - 6.0 mm ² 12 - 10 AWG	27.0	4.8	3.6		100

İZOLESİZ EK MUFLARI

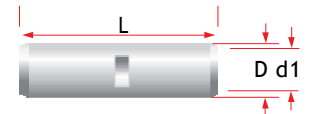



Sipariş Kodu	Kablo Kesitleri	Ölçüler (mm)			Renkler	Kutu Adedi
		L	D	d1		
BCT-0.5 N	0.1 - 0.5 mm ² 26 - 22 AWG	12.0	2.0	1.0		200
BCT-1N	0.5 - 1.5 mm ² 22 - 16 AWG	15.0	3.3	1.6		100
BCT-2N	1.5 - 2.5 mm ² 16 - 14 AWG	15.0	4.0	2.3		100
BCT-5N	4.0 - 6.0 mm ² 12 - 10 AWG	15.0	5.5	3.6		100
BCT-8N	8 mm ² 8 AWG	21.0	7.0	4.5		100

İZOLELİ EKSTRA YÜKSÜKLÜ ERKEK KABLO UCU

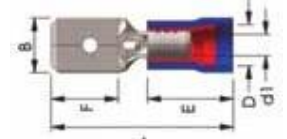
Pirinç malzemeden kalay kaplı, PVC izoleli, 75°C çalışması sıcaklığı, 300 Volt enerjiye dayanabilme özelliğine sahiptir.





Sipariş Kodu	Kablo Kesitleri	Soket Genişliği	Ölçüler (mm)							Renkler	Kutu Adedi
			B	F	L	E	D	d1			
M1-2.8VD/5	0.5 - 1.5 mm 22 - 16 AWG	0.5 x 2.8	2.8	7.0	19.2	10.0	4.3	1.7		EXTRA YÜKSÜK	200
M1-2.8VD/8		0.8 x 2.8	2.8	7.8	20.5						200
M1-4.8VD/5		0.5 x 4.8	4.8	7.0	19.2						200
M1-4.8VD/8		0.8 x 4.8	4.8	7.8	20.5						200
M1 - 6.4 VD		0.8 x 6.4	6.4	7.8	21.2						200
M2-2.8VD/5	1.5 - 2.5 mm 16 - 14 AWG	0.5 x 2.8	2.8	7.0	19.2	10.0	5.0	2.3		EXTRA YÜKSÜK	200
M2-2.8VD/8		0.8 x 2.8	2.8	7.8	20.5						200
M2-4.8VD/5		0.5 x 4.8	4.8	7.0	19.2						200
M2-4.8VD/8		0.8 x 4.8	4.8	7.8	20.5						200
M2 - 6.4 VD		0.8 x 6.4	6.4	7.8	21.2						200
M5 - 6.4 VD	4.0 - 6.0 mm 12 - 10 AWG	0.8 x 6.4	6.4	7.8	23.7	12.5	6.5	3.4		YÜKSÜK	100

FULL İZOLELİ EKSTRA YÜKSÜKLÜ ERKEK GERİ DÖNÜŞLÜ DİŞİ KABLO UCU

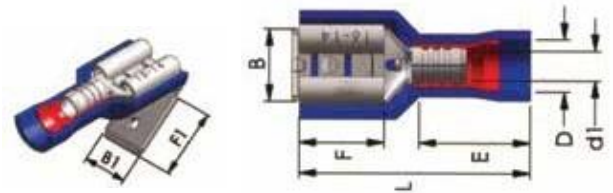
Pirinç malzemeden kalay kaplı, PVC izoleli, 75°C çalışması sıcaklığı, 300 Volt enerjiye dayanabilme özelliğine sahiptir.





Sipariş Kodu	Kablo Kesitleri	Soket Genişliği	Ölçüler (mm)								Renkler	Kutu Adedi	
			B	B1	F	F1	L	E	D	d1			
PB1-6.4VFD	0.5 - 1.5 mm 22 - 16 AWG	0.8 x 6.4	6.6	6.4	8.0	8.2	22.0	10.0	4.3	1.7		EXTRA YÜKSÜK	100
PB2-6.4VFD	1.5 - 2.5 mm 16 - 14 AWG	0.8 x 6.4	6.6	6.4	8.0	8.2	22.0	10.0	5.0	2.3		EXTRA YÜKSÜK	100
PB5-6.4VFD	4.0 - 6.0 mm 12 - 10 AWG	0.8 x 6.4	6.6	6.4	8.0	8.2	25.0	13.0	6.5	3.4		EXTRA YÜKSÜK	100

İĞNE TİP KABLO UCU

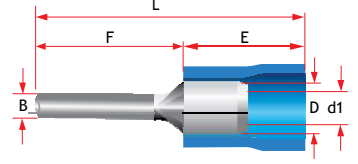
Bakır malzemeden kalay kaplı, PVC izoleli, 75 °C çalışma sıcaklığı, 600 Volt enerjiye dayanabilme özelliğinesahiptir.





Sipariş Kodu	Kablo Kesitleri	Ölçüler (mm)						Renkler	Kutu Adedi
		B	F	L	E	D	d1		
PT1-10V	0.5 - 1.5 mm 22 - 16 AWG	1.9	10.5	20.5	10.0	4.1	1.7		200
PT2-10V	1.5 - 2.5 mm 16 - 14 AWG	1.9	10.5	20.5	10.0	4.5	2.3		200
PT2-12V		1.9	12.5	22.5					200
PT2-18V		1.9	18.5	28.5					100
PT5-13V	4.0 - 6.0 mm 12 - 10 AWG	2.8	13.7	26.2	12.5	6.5	3.4		100

BIÇAK TİP KABLO UCU

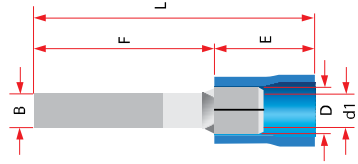
Bakır malzemeden kalay kaplı, Naylon izoleli, 105 °C çalışma sıcaklığı, 600 Volt enerjiye dayanabilme özelliğine sahiptir.

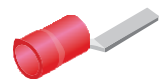
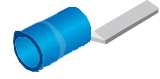

Sipariş Kodu	Kablo Kesitleri	Ölçüler (mm)						Renkler	Kutu Adedi
		B	F	L	E	D	d1		
BT1-10A	0.5 - 1.5 mm 22 - 16 AWG	2.4	10.5	21.5	11.0	4.1	1.7		100
BT1-14A		3.0	11.0	22.0					100
BT1-18A		3.0	14.0	25.0					100
BT2-9A	1.5 - 2.5 mm 16 - 14 AWG	2.8	9.0	20.0	11.0	4.5	2.3		100
BT2-18A		2.8	18.0	29.0					100
BT5-18A	4.0 - 6.0 mm 12 - 10 AWG	3.0	18.0	31.0	13.0	6.5	3.4		100

UCU KIVRIK İZOLELİ BIÇAK TERMİNALLER

Bakır malzemeden kalay kaplı, Naylon izoleli, 105 °C çalışma sıcaklığı, 600 Volt enerjiye dayanabilme özelliğine sahiptir.

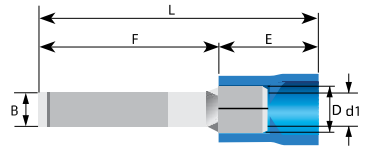

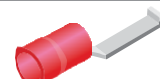
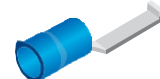
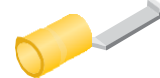

Sipariş Kodu	Kablo Kesitleri	Ölçüler (mm)						Renkler	Kutu Adedi
		B	F	L	E	D	d1		
LB1-3V	0.5 - 1.5 mm 22 - 16 AWG	3.0	18.0	29.0	11.0	4.1	1.7		200
LB1-4.6V		4.6							
LB2-3V	1.5 - 2.5 mm 16 - 14 AWG	3.0	18.0	29.0	11.0	4.5	2.3		100
LB2-4.6V		4.6							
LB5-3V	4.0 - 6.0 mm 12 - 10 AWG	3.0	17.5	30.5	13.0	6.5	3.4		100
LB5-4.6V		4.6							

İZOLELİ BAYRAK TİP KABLO UCU

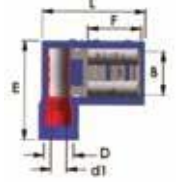

Pirinç malzemeden kalay kaplı, Polyamid izoleli, 105 °C çalışma sıcaklığı, 300 Volt enerjiye dayanabilme özelliğine sahiptir.



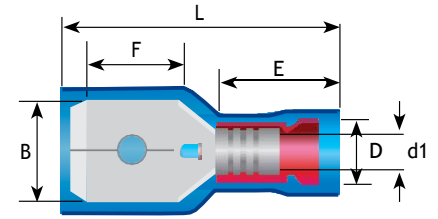
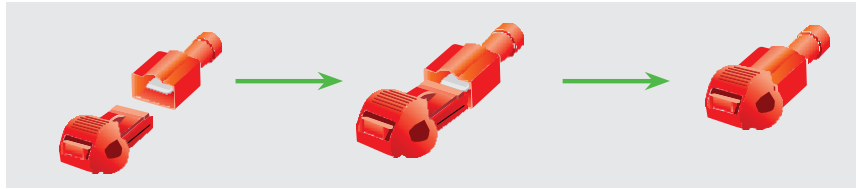

Sipariş Kodu	Kablo Kesitleri	Soket Genişliği	Ölçüler (mm)						Renkler	Kutu Adedi
			B	F	L	E	D	d1		
FL1-6.4AC	0.5 - 1.5 mm 22 - 16 AWG	0.8 x 6.4	6.6	7.9	16.1	15.0	4.5	1.7		100
FL2-6.4AC	1.5 - 2.5 mm 16 - 14 AWG	0.8 x 6.4	6.6	7.9	16.1	15.0	4.5	2.3		100

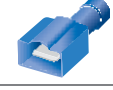
FULL İZOLELİ ERKEK TERMİNAL & T BAĞLANTI TERMİNALİ

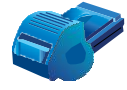

Sipariş Kodu	Kablo Kesitleri	Ölçüler (mm)						Renkler	Kutu Adedi
		B	F	L	E	D	d1		
M1-6.4AFC	0.5 - 1.5 mm 22 - 16 AWG	6.35	7.9	23.5	10.5	4.2	1.7		100
M2-6.4AFC	1.5 - 2.5 mm 16 - 14 AWG	6.35	7.9	23.5	10.5	4.9	2.3		100
M5-6.4AFC	4.0 - 6.0 mm 12 - 10 AWG	6.35	7.9	27.0	13.0	6.5	3.4		100

Sipariş Kodu	Kablo Kesitleri	Ölçüler (mm)		Renkler	Kutu Adedi	Adet Fiyatı (\$)
		B	L			
SPM1A	0.5 - 1.5 mm 22 - 16 AWG	6.35	23.5		100	0,062 USD
SPM2A	1.5 - 2.5 mm 16 - 14 AWG	6.35	23.5		100	0,065 USD
SPM5A	4.0 - 6.0 mm 12 - 10 AWG	6.35	27.0		100	0,095 USD

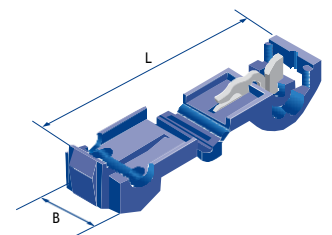

Pirinç malzemeden kalay kaplı, Naylon izoleli, 105 °C çalışma sıcaklığı, 600 Volt enerjiye dayanabilme özelliğine sahiptir.

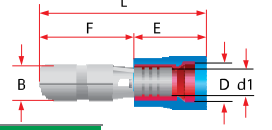

İZOLELİ EKSTRA YÜKSÜKLÜ YUVARLAK ERKEK KABLO UCU

Pirinçmalzemededen kalay kaplı, PVC izoleli, 75°C çalışmasıcaklığı, 300 Volt enerjiye dayanabilme özelliğinesahiptir.

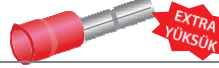



Sipariş Kodu	Kablo Kesitleri	Ölçüler (mm)						Renkler	Kutu Adedi
		B	F	L	E	D	d1		
BD1-4VD	0.5 - 1.5 mm 22 - 16 AWG	4.0	8.5	21.0	10.0	4.3	1.7	 EXTRA YÜKSÜK	200
BD2-4VD	1.5 - 2.5 mm	4.0	8.5	21.0	10.0	5.0	2.3	 EXTRA YÜKSÜK	200
BD2-5VD	16 - 14 AWG	5.0	8.5	21.0					200
BD5-5VD	4.0 - 6.0 mm 12 - 10 AWG	5.0	8.5	23.5	13.0	6.5	3.4	 EXTRA YÜKSÜK	100

FULL İZOLELİ EKSTRA YÜKSÜKLÜ YUVARLAK DIŞI KABLO UCU

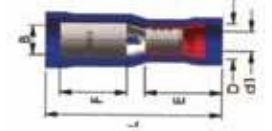
Pirinçmalzemededen kalay kaplı, PVC izoleli, 75°C çalışmasıcaklığı, 300 Volt enerjiye dayanabilme özelliğinesahiptir.





Sipariş Kodu	Kablo Kesitleri	Ölçüler (mm)						Renkler	Kutu Adedi
		B	F	L	E	D	d1		
RE1-4VFD	0.5 - 1.5 mm 22 - 16 AWG	4.0	9.0	23.5	11.0	4.3	1.7	 EXTRA YÜKSÜK	100
RE2-4VFD	1.5 - 2.5 mm	4.0	9.0	23.5	11.0	5.0	2.3	 EXTRA YÜKSÜK	100
RE2-5VFD	16 - 14 AWG	5.0	9.0	23.5					100
RE5-5VFD	4.0 - 6.0 mm 12 - 10 AWG	5.0	9.0	25.0	13.0	6.5	3.4	 EXTRA YÜKSÜK	100

İZOLELİ ÇENGEL KABLO UCU

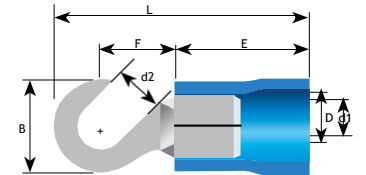
Bakırmalzemeden kalay kaplı, PVC izoleli, 75°C çalışmasıcaklığı, 600 Volt enerjiye dayanabilme özelliğinesahiptir.



Sipariş Kodu	Kablo Kesitleri	Metrik Ölçüsü	Ölçüler (mm)						Renkler	Kutu Adedi
			B	F	L	E	D	d1		
H1- 4V	0.5 - 1.5 mm 22 - 16 AWG	4.3	8.0	7.0	21.0	10.0	4.1	1.7		200
H1- 5V		5.3	8.0	7.0	21.0					200
H1- 6V		6.5	11.6	11.1	26.8					200
H2- 4V	1.5 - 2.5 mm 16 - 14 AWG	4.3	8.5	7.8	22.0	10.0	4.5	2.3		200
H2- 5V		5.3	9.5	7.3	22.0					200
H2- 6V		6.5	12.0	11.0	27.0					200
H5 - 4V	4.0 - 6.0 mm 12 - 10 AWG	4.3	9.5	8.3	25.5	12.5	6.5	3.4		100
H5 - 5V		5.3	9.5	8.3	25.0					100
H5 - 6V		6.5	12.0	10.5	29.0					100

VİDALI BUAT KLEMENSLER

Dayanıklı termoplastik hammaddeden imal edilmiş olup, UL 94 / V2 normunda 105°C çalışma sıcaklığında, bina elektrik tesisatı için 600V aydınlatma ve sinyalizasyon için 1000 V'a kadar dayanabilme özelliğine sahiptir.

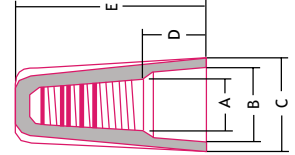

Sipariş Kodu	Ölçüler (mm)					RENKLER	Kutu Adedi
	A	B	C	D	E		
P-1	3.80	6.70	8.60	5.80	15.20		500
P-2	4.10	7.00	9.80	5.90	17.60		500
P-3	5.00	9.90	12.20	7.80	22.00		500
P-4	6.00	11.20	14.00	7.90	24.00		250
P-6	7.50	13.00	16.40	9.15	26.50		100

KULAKLI TİP VİDALI BUAT KLEMENSLERİ

Dayanıklı termoplastik hammaddeden imal edilmiş olup, UL 94 / V2 normunda 105°C çalışma sıcaklığında, bina elektrik tesisatı için 600V aydınlatma ve sinyalizasyon için 1000 V'a kadar dayanabilme özelliğine sahiptir.

Sipariş Kodu	Ölçüler (mm)					RENKLER	Kutu Adedi
	A	B	C	D	E		
P-11V	6.40	9.80	18.20	9.00	25.80		500
P-12	7.20	11.60	18.30	9.20	29.00		500
P-13	9.00	13.00	23.00	9.60	31.80		500
P-15	10.00	14.90	25.50	10.00	33.30		250
P-17	12.00	17.80	32.00	13.00	40.00		100

KAPAMA PARÇASI

Naylon 66 hammaddeden imal edilmiş olup, UL 94 / V2 normunda, 105 °C çalışma sıcaklığında 300 Volt enerjiye dayanabilme özelliğine sahiptir. (CE-8) Modeli 600 Volt enerjiye dayanabilme özelliğine sahiptir.

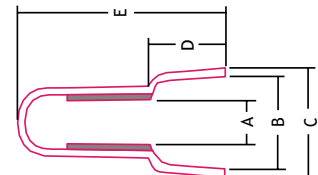

Sipariş Kodu	Ölçüler (mm)					Renkler	Kutu Adedi
	A	B	C	D	E		
CE-1	2.6	6.2	7.8	6.0	18.0		1.000
CE-2	3.1	7.9	9.5	7.0	20.0		1.000
CE-5	4.4	10.5	12.5	9.6	25.5		1.000
CE-8	5.3	12.4	14.3	12.0	27.7		500

AÇILABİLİR BUATKLEMENSLERİ

Sipariş Kodu Mini	Kutup Sayısı	Kablo Kesiti	Ölçüler (mm)			Poşet Adedi
			A	B	H	
PC - 622	2	0.2 - 4 mm ²	12.2	20.7	14.5	500
PC - 623	3	0.2 - 4 mm ²	16.8	20.7	14.5	500
PC - 625	5	0.2 - 4 mm ²	26.0	20.7	14.5	300

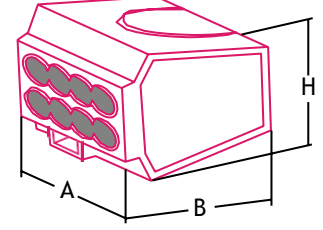

GEÇMELİ BUAT KLEMENSLERİ ŞEFFAF (TRANSPARAN)

Termoplastik hammaddeden imal edilmiş olup, UL94 / V2 normunda, 105 °C çalışma sıcaklığında 600 V enerjiye dayanabilen 24 A akım geçirgenliğine sahiptir. Sadece 2,5 mm² tek damar kablolar içindir.

Sipariş Kodu	Renk	Kutup Sayısı	Kablo Kesiti	Ölçüler (mm)			Poşet Adedi
				A	B	H	
PC - 252CL	2 (Kırmızı)	2	0.5 - 2.5 mm ²	10.5	19.5	9.5	500
PC - 253CL	3 (Oranj)	3	0.5 - 2.5 mm ²	13.5	19.7	9.5	500
PC - 254CL	4 (Sarı)	4	0.5 - 2.5 mm ²	17.2	19.7	9.5	500
PC - 255CL	5 (Gri)	5	0.5 - 2.5 mm ²	21.1	19.7	9.5	500
PC - 258CL	8 (Siyah)	8	0.5 - 2.5 mm ²	17.5	19.0	16.8	250



Sipariş Kodu Mini	Renk	Kutup Sayısı	Kablo Kesiti	Ölçüler (mm)			Poşet Adedi
				A	B	H	
PC - 212	2 (Kırmızı)	2	0.5 - 2.5 mm ²	10.6	16.0	7.5	1.000
PC - 213	3 (Oranj)	3	0.5 - 2.5 mm ²	15.0	16.0	7.5	1.000
PC - 214	4 (Sarı)	4	0.5 - 2.5 mm ²	19.4	16.0	7.5	500
PC - 215	5 (Gri)	5	0.5 - 2.5 mm ²	23.7	16.0	7.5	500
PC - 216	6 (Mor)	6	0.5 - 2.5 mm ²	28.3	16.0	7.5	500

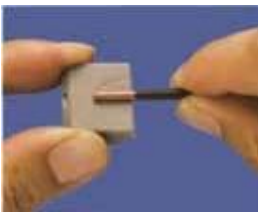
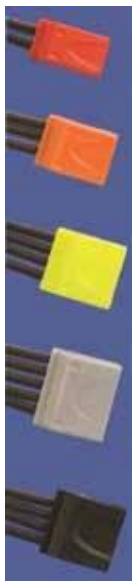

1- Kablo Boyu 11mm olacak şekilde açınız.

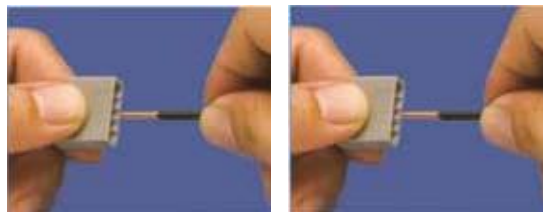

2- Kablo sıralamalarından emin olduktan sonra tüm kabloları sokete itiniz.



3- Bağlantının doğruluğunu test etmek için yuvayı, voltaj test aleti ile kontrol ediniz.



HIZLI KABLO EKLEME PARÇASI

Sipariş Kodu	Kablo Kesiti	Ölçüler (mm)			Poşet Adedi
		B	H	L	
SP-1	0.5 - 1.0	20.0	8.0	25.0	500
SP-2	1.0 - 2.5	20.0	8.0	25.0	500
SP-5	4.0 - 6.0	20.0	11.0	35.0	250

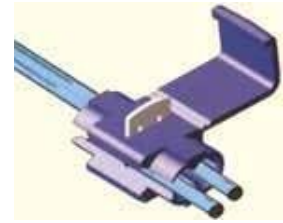
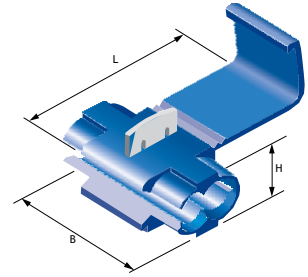

PANELE KABLO KİTLEME PARÇASI

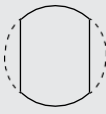
Sipariş Kodu	Panel Kesit Şekli	Ölçüler (mm)				Poşet Adedi
		A	B	F	D	
2 P - 4		9.5	8.7	1.6	10.3	1.000
3 P - 4		11.0	9.9	1.6	10.3	1.000
3 W - 1		11.0	9.9	2.5	10.3	1.000
4 N - 4		12.7 - 12.1	11.8	1.6	10.3	1.000
4 K - 4		12.7 - 13.1	11.8	2.5	10.3	1.000

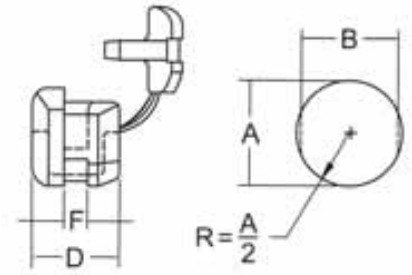

5 N - 4		12.7 - 12.1	11.5	1.6	11.0	1.000
5 P - 4		12.7 - 12.1	11.5	2.5	11.0	1.000
6 N - 4		15.9	14.0	1.6	14.8	500
6 P - 4		15.9	14.0	3.2	14.8	500
6 N 3 - 4		15.9	14.0	1.6	14.8	500
6 P3 - 4		15.9	14.0	3.2	14.8	500
7 N - 2		19.0 - 19.8	16.8	1.2	19.0	100
7 P - 2		19.0 - 19.8	16.8	3.2	19.0	100
8 P - 2		22.2	21.3	3.2	20.8	100

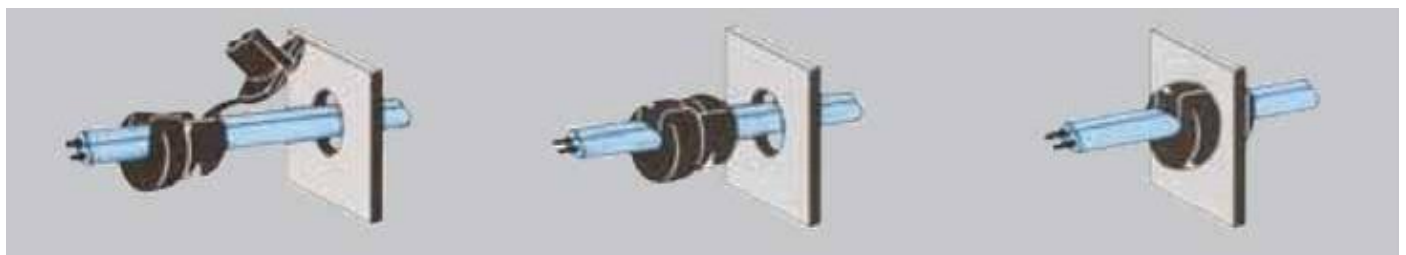

1) Kablonuzu kilitleme parçası arasınayleştiriniz

2) Kilitleme parçasındaki ek parça ile kablonuzu sıkıştırınız

3) İterek panele sabitleyiniz

SKP ve MÜŞTEREK W OTOMAT BARALARI

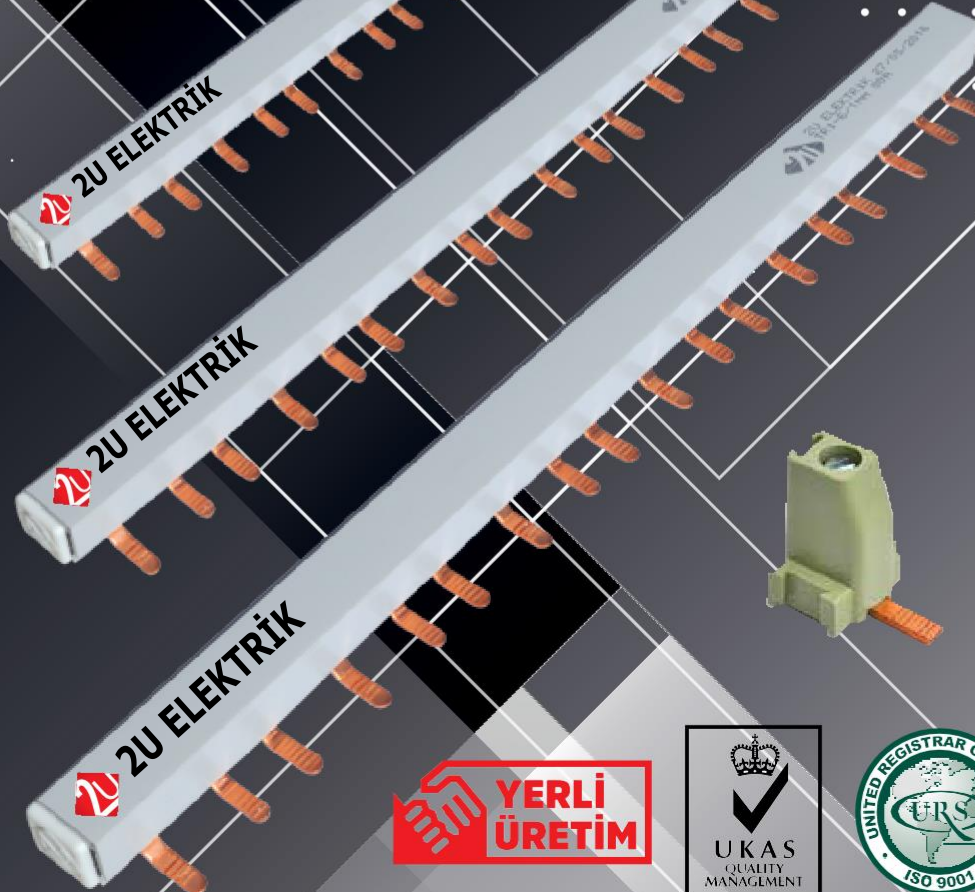
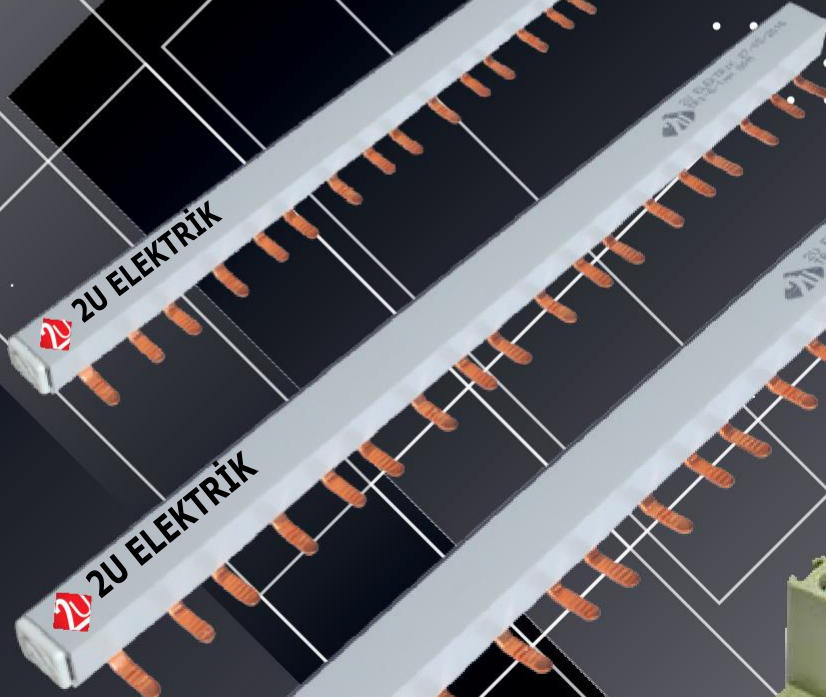
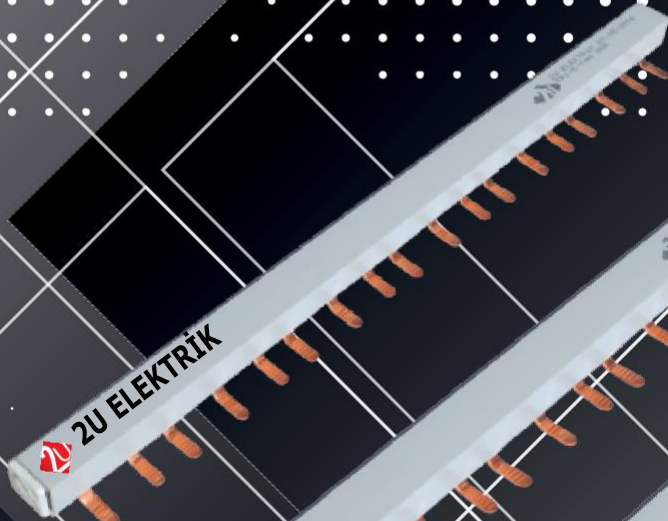

Registration No 043



ISO 9001:2008



Kalite Yönetim Sistemi
TS EN 61439-1: 2012
AC: 2014, T1: 2014



İZOLESİZ (Kaynaklı) YUVARLAK KABLO UCU (DIN 46234)

DIN 46234 Standartlı, Bakır malzemeden Kalay kaplı

IKUMA Sip. Kodu	JEESON Sip. Kodu	Ölçüler (mm)							Kutu Adedi
		Kablo Kesiti (mm ²)	Metrik Ölçüsü	d ₁	I ₁	b	I ₂	d ₂	
102002	DR3-1NB	0.5 - 1	M3	1.6	10.8	6.0	4.8	3,2	1.000
102004	DR3,5-1NB		M3.5	1.6	10.8	6.0	4.8	3,7	1.000
102006	DR4-1NB		M4	1.6	11.8	8.0	4.8	4,3	1.000
102008	DR5-1NB		M5	1.6	12.8	10.0	4.8	5,3	1.000
102010	DR6-1NB		M6	1.6	14.8	11.0	4.8	6,5	1.000
102011	DR8-1NB		M8	1.6	17.0	14.0	4.8	8,4	1.000
102012	DR3-2NB	1,5 - 2,5	M3	2.3	10.8	6.0	4.8	3,2	1.000
102014	DR3,5-2NB		M3.5	2.3	10.8	6.0	4.8	3,7	1.000
102016	DR4-2NB		M4	2.3	11.8	8.0	4.8	4,3	1.000
102018	DR5-2NB		M5	2.3	13.8	10.0	4.8	5,3	1.000
102020	DR6-2NB		M6	2.3	15.8	11.0	4.8	6,5	1.000
102022	DR8-2NB		M8	2.3	16.8	14.0	4.8	8,4	1.000
102023	DR10-2NB	4 - 6	M10	2.3	17.0	15.0	4.8	10.5	1.000
102023-B	DR12-2NB		M12	2.3	20.0	18.0	4.8	12.0	1.000
102024	DR4-6NB		M4	3.6	14.0	8.0	6.0	4,3	100
102026	DR5-6NB		M5	3.6	15.0	10.0	6.0	5,3	100
102028	DR6-6NB		M6	3.6	16.0	11.0	6.0	6,5	100
102030	DR8-6NB		M8	3.6	19.0	14.0	6.0	8,4	100
102032	DR10-6NB	10	M10	3.6	21.0	18.0	6.0	10.5	100
102033	DR12-6NB		M12	3.6	21.0	18.0	6.0	13.0	100
102036	DR5-10NB		M5	4.5	16.0	10.0	8.0	5,3	100
102038	DR6-10NB		M6	4.5	17.0	11.0	8.0	6,5	100
102040	DR8-10NB		M8	4.5	20.0	14.0	8.0	8,4	100
102042	DR10-10NB		M10	4.5	21.0	18.0	8.0	10.5	100
102044	DR12-10NB	16	M12	4.5	23.0	22.0	8.0	13.0	100
102046	DR5-16NB		M5	5.8	20.0	11.0	10.0	5,3	100
102048	DR6-16NB		M6	5.8	20.0	11.0	10.0	6,5	100
102050	DR8-16NB		M8	5.8	22.0	14.0	10.0	8,4	100
102052	DR10-16NB		M10	5.8	24.0	18.0	10.0	10.5	100
102054	DR12-16NB		M12	5.8	26.0	22.0	10.0	13.0	100
102056	DR5-25NB	25	M5	7.5	25.0	12.0	11.0	5,3	100
102058	DR6-25NB		M6	7.5	25.0	12.0	11.0	6,5	100
102060	DR8-25NB		M8	7.5	25.0	16.0	11.0	8,4	100
102062	DR10-25NB		M10	7.5	26.0	18.0	11.0	10.5	100
102064	DR12-25NB		M12	7.5	31.0	22.0	11.0	13.0	100
102068	DR16-25NB		M16	7.5	35.0	28.0	11.0	17.0	100
102070	DR6-35NB	35	M6	9.0	26.0	15.0	12.0	6,5	100
102072	DR8-35NB		M8	9.0	26.0	16.0	12.0	8,4	100
102074	DR10-35NB		M10	9.0	27.0	18.0	12.0	10.5	100
102076	DR12-35NB		M12	9.0	31.0	22.0	12.0	13.0	100
102080	DR16-35NB		M16	9.0	35.0	28.0	12.0	17.0	100
102082	DR6-50NB		50	M6	11.0	34.0	18.0	16.0	6,5
102084	DR8-50NB	M8		11.0	34.0	18.0	16.0	8,4	100
102086	DR10-50NB	M10		11.0	34.0	18.0	16.0	10.5	100
102088	DR12-50NB	M12		11.0	36.0	22.0	16.0	13.0	100
102092	DR16-50NB	M16		11.0	40.0	22.0	16.0	17.0	100

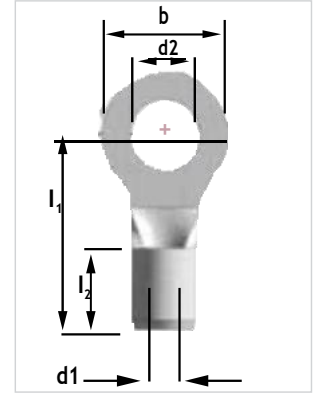

İZOLESİZ (Kaynaklı) ÇATAL KABLO UCU

Sipariş Kodu	Metrik Ölçüsü (d2)	B	L	F	E	D	d1	Kutu Adedi
S1 - 3 NB	3.2	5.8	16.0	6.3	10.0	5.0	1.7	1.000
S1 - 4 MNB	4.3	7.2	16.0	6.3	10.0	5.0	1.7	1.000
S1 - 5 SNB	5.3	8.0	16.0	7.0	10.0	5.0	1.7	1.000
S1 - 6 SNB	6.5	9.5	22.2	7.0	10.0	5.0	1.7	1.000
S1 - 8 NB	8.4	12.0	16.0	11.0	10.0	5.0	1.7	1.000
S2 - 3 NB	3.2	5.8	16.2	6.3	10.0	5.0	2.3	1.000
S2 - 4 MNB	4.3	7.2	16.2	6.5	10.0	5.0	2.3	1.000
S2 - 5 SNB	5.3	8.5	17.0	7.3	10.0	5.0	2.3	1.000
S2 - 6 SNB	6.5	9.5	17.0	7.3	10.0	5.0	2.3	1.000
S2 - 8 NB	8.4	12.0	22.0	11.0	10.0	5.0	2.3	1.000
S5 - 4 SNB	4.3	8.5	18.7	7.5	10.0	6.0	3.4	500
S5 - 5 NB	5.3	9.5	18.7	7.5	10.0	6.0	3.4	500
S5 - 6 SNB	6.5	9.5	18.7	7.5	10.0	6.0	3.4	500
S5 - 8 NB	8.4	13.5	23.5	10.5	10.0	6.0	3.4	500
S8 - 4 NB	4.3	8.2	20.5	8.1	10.0	8.5	4.5	500
S8 - 5 NB	5.3	9.0	20.5	8.1	10.0	8.5	4.5	500
S8 - 6 NB	6.5	10.8	22.5	8.6	10.0	8.5	4.5	500

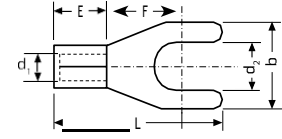

EK MUFLARI

Sip. Kodu	Kablo Kes. (mm ²)	L	d	D	L ₁	Kutu Adedi
SEM-A/006	6	25.0	4.0	5.5	-	800
SEM-A/010	10	30.0	4.5	6.0	-	600
SEM-A/016	16	35.0	5.5	7.5	3.0	300
SEM-A/025	25	40.0	7.0	9.5	3.5	200
SEM-A/035	35	45.0	8.5	11.0	3.5	150
SEM-A/050	50	50.0	10.0	13.0	4.5	125
SEM-A/070	70	55.0	11.5	14.5	4.5	80
SEM-A/095	95	60.0	13.5	16.5	4.5	60
SEM-A/120	120	65.0	14.5	18.0	7.0	40
SEM-A/150	150	70.0	16.5	21.0	7.0	30
SEM-A/185	185	75.0	18.5	23.0	7.0	20
SEM-A/240	240	85.0	21.0	26.0	7.0	15
SEM-A/300	300	100.0	23.5	28.5	7.5	10
SEM-A/400	400	110.0	27.0	33.0	7.5	6

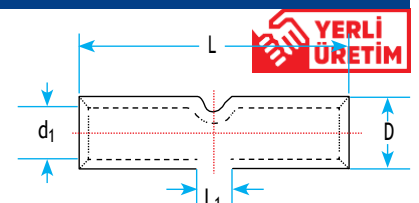

BİMETALİK SKP (Alüminyum Gövde, Bakır Başlık)

REF. NO	K. KESİTİ mm ²	ØE	ØI	L	ØT	L1	K. AD.
TBF-16	16	16	5,6	79	8,4	48,5	70
TBF-25	25	16	6,4	79	8,4	48,5	70
TBF-35	35	16	8,5	79	8,4	48,5	70
TBF-50	50	20	9,4	88	10,5	51	48
TBF-70	70	20	10,9	88	12,8	51	48
TBF-95	95	20	12,4	88	12,8	51	48
TBF-120	120	25	13,7	110	12,8	67	20
TBF-150	150	25	15,5	110	12,8	67	20
TBF-185	185	32	17	117	12,8	68	15
TBF-240	240	32	19,5	117	12,8	68	15
TBF-300	300	40	23,2	155,5	16,5	104,5	6
TBF-400	400	40	26	155,5	16,5	104,5	6
TBF-500	500	47	29	193	17	109	-

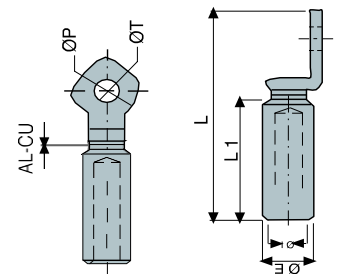

EKONOMİK TİP SKP KABLO UCU

Bakır malzemeden kalay kaplı

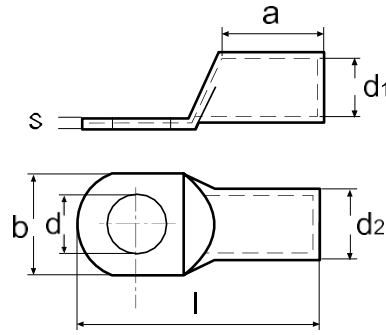

Sipariş Kodu	Kablo Kesiti	Metrik	Ölçüler (mm)							Kutu Adedi	Kutu Ağırlığı
			d	d ₁	d ₂	l	a	b	s		
SKP-E 10/M05	10	M5	5,3	4,5	6,0	27	9	8,6	1,5	800	2,10 Kg
SKP-E 16/M06	16	M6	6,4	5,5	7,0	30	11,0	10,5	1,5	500	1,70 Kg
SKP-E 25/M08	25	M8	8,3	7,0	9,0	38,5	12,0	13,0	2,0	350	2,20 Kg
SKP-E 35/M08	35	M8	8,3	8,5	10,5	43,5	14,0	15,5	2,0	200	2,00 Kg
SKP-E 50/M10	50	M10	10,3	10,0	12,0	51,5	17,0	17,9	2,0	150	2,20 Kg
SKP-E 70/M10	70	M10	10,3	11,5	14,0	55,5	18,0	20,7	2,5	100	2,30 Kg
SKP-E 95/M12	95	M10	10,3	13,5	16,0	58,5	21,0	23,5	2,5	80	2,20 Kg
SKP-E 120/M12	120	M12	12,8	15,5	18,0	71,0	25,0	26,7	2,5	50	1,90 Kg
SKP-E 150/M12	150	M12	12,8	16,5	20,0	76,0	26,0	29,2	3,5	40	2,10 Kg
SKP-E 185/M16	185	M16	16,5	18,5	22,0	82,0	29,0	32,3	3,5	30	2,15 Kg
SKP-E 240/M16	240	M16	16,5	21,5	25,5	91,0	33,0	37,6	4,0	25	2,70 Kg

DAR GİRİŞLİ SKP KABLO UCU

Özel siparişe 900 üretimi yapılabilir.

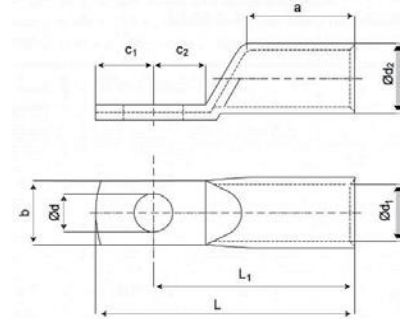

Sipariş Kodu	Kablo Kesiti	Metrik	Ölçüler (mm)									Kutu Adedi	Kutu Ağırlığı
			d	d ₁	d ₂	l	l ₁	a	b	c ₁	c ₂		
SKP-DG-03506	35 mm ²	M6	6.5	8.5	12	39.5	32	17	15	7.5	7.5	150	~2.9 Kg
SKP-DG-05006	50 mm ²	M6	6.5	10	14	47	37	19	15	10	10	120	~3.8 Kg
SKP-DG-05008		M8	8.5	10	14	47	37	19	17	10	10	120	~3.8 Kg
SKP-DG-05010		M10	10.5	10	14	51	39	19	19	12	12	120	~3.7 Kg
SKP-DG-07008	70 mm ²	M8	8.5	12.0	16.5	53	43	21	17	10	10	80	~3.5 Kg
SKP-DG-07010		M10	10.5	12.0	16.5	56	44	21	19	12	12	80	~3.4 Kg
SKP-DG-07012		M12	13.0	12.0	16.5	59	46	21	19	13	13	80	~3.8 Kg
SKP-DG-09508	95 mm ²	M8	8.5	13.5	18.0	60	48	25	19	12	12	60	~3.5 Kg
SKP-DG-09510		M10	10.5	13.5	18.0	60	48	25	19	12	12	60	~3.4 Kg
SKP-DG-09512		M12	13.0	13.5	18.0	62	49	25	19	13	13	60	~3.2 Kg
SKP-DG-12008	120 mm ²	M8	8.5	15	19.5	65	51	26	19	14	14	50	~3.1 Kg
SKP-DG-12010		M10	10.5	15	19.5	65	51	26	19	14	14	50	
SKP-DG-12012		M12	13.0	15	19.5	65	51	26	19	14	14	50	
SKP-DG-15008	150 mm ²	M8	8.5	16.5	21	70	56	30	19	14	14	30	~2.4 Kg
SKP-DG-15010		M10	10.5	16.5	21	70	56	30	19	14	14	30	~2.4 Kg
SKP-DG-15012		M12	13.0	16.5	21	72	57	30	19	15	15	30	~2.3 Kg
SKP-DG-18510	185 mm ²	M10	10.5	19	24	83	65	30	24.5	18	18	25	~2.9 Kg
SKP-DG-18512		M12	13.0	19	24	83	65	30	31	18	18	25	
SKP-DG-18516		M16	17	19	24	83	65	30	31	18	18	25	
SKP-DG-24010	240 mm ²	M10	10.5	21.2	26.6	95	72	39	31	17	18	25	~3.7Kg
SKP-DG-24012		M12	13	21.2	26.6	95	72	39	31	17	18	25	
SKP-DG-24016		M16	17	21.2	26.6	95	72	39	31	17	18	25	

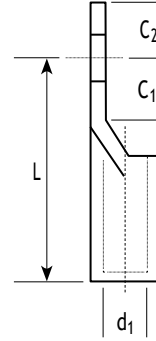
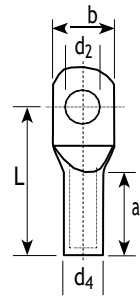

STANDART TİP SKP KABLO UCU

Bakır malzemeden kalay kaplı

Sipariş Kodu	Kablo Kesiti	Metrik	Ölçüler (mm)								Kutu Adedi	Kutu Ağırlığı
			d1	d4	a	d2	b	c1	c2	L		
SKP / S 6-4	6	M4	4,0	5,5	9,5	4,3	9,0	6,5	6,5	19,0	1.000	-2.3 Kg
SKP / S 6-5		M5	4,0	5,5	9,5	5,3	9,0	6,5	6,5	19,0	1.000	-2.2 Kg
SKP / S 6-6		M6	4,0	6,0	11,0	6,4	10,5	7,0	7,0	21,0	700	-2.4 Kg
SKP / S 6-8		M8	4,0	6,0	11,0	8,4	13,0	8,0	8,0	22,5	600	-2.2 Kg
SKP / S 10-5	10	M5	4,5	6,0	11,5	5,3	9,0	7,0	7,0	21,0	800	-2.3 Kg
SKP / S 10-6		M6	4,5	6,5	13,0	6,4	10,5	7,0	7,0	23,0	800	-2.2 Kg
SKP / S 10-8		M8	4,5	6,5	13,0	8,4	13,0	8,0	8,0	24,5	600	-2.2 Kg
SKP / S 10-10		M10	4,5	6,5	13,0	10,5	15,0	8,5	8,5	26,5	500	-2.2 Kg
SKP / S 16-6	16	M6	5,5	7,5	12,5	6,5	11,5	7,5	7,5	24,0	500	-2.0 Kg
SKP / S 16-8		M8	5,5	7,5	13,0	8,4	13,0	8,0	8,0	25,0	500	-2.1 Kg
SKP / S 16-10		M10	5,5	7,5	13,0	10,5	15,0	8,5	8,5	26,5	400	-1.5 Kg
SKP / S 25-6	25	M6	7,0	9,5	17,5	6,5	14,0	8,5	8,5	30,5	300	-2.8 Kg
SKP / S 25-8		M8	7,0	9,5	17,5	8,5	14,0	8,5	8,5	30,5	350	-2.5 Kg
SKP / S 25-10		M10	7,0	9,5	17,5	10,5	16,0	10,0	10,0	31,5	250	-2.4 Kg
SKP / S 25-12		M12	7,0	9,5	17,5	13,0	18,0	11,0	11,0	35,0	200	-2.4 Kg
SKP / S 35-6	35	M6	8,5	11,0	19,0	6,5	16,0	9,5	9,5	34,5	200	-2.6 Kg
SKP / S 35-8		M8	8,5	11,0	19,0	8,5	16,0	9,5	9,5	34,5	200	-2.6 Kg
SKP / S 35-10		M10	8,5	11,0	19,0	10,5	16,5	10,0	10,0	34,5	200	-2.5 Kg
SKP / S 35-12		M12	8,5	11,0	19,0	13,0	18,0	11,0	11,0	36,5	150	-1.9 Kg
SKP / S 50-6	50	M6	10,0	13,0	20,0	6,5	19,0	11,0	11,0	39,5	125	-2.8 Kg
SKP / S 50-8		M8	10,0	13,0	20,0	8,5	19,0	11,0	11,0	39,5	150	-2.8 Kg
SKP / S 50-10		M10	10,0	13,0	20,0	10,5	19,0	11,0	11,0	39,5	150	-2.6 Kg
SKP / S 50-12		M12	10,0	13,0	20,0	13,0	19,0	11,0	11,0	39,5	150	-2.4 Kg
SKP / S 70-6	70	M6	11,5	14,5	21,5	6,5	21,0	11,0	11,0	41,5	100	-2.1 Kg
SKP / S 70-8		M8	11,5	14,5	21,5	8,5	21,0	11,0	11,0	41,5	100	-2.1 Kg
SKP / S 70-10		M10	11,5	14,5	21,5	10,5	21,0	11,0	11,0	41,5	100	-2.1 Kg
SKP / S 70-12		M12	11,5	14,5	21,5	13,0	21,0	11,0	11,0	41,5	100	-2.1 Kg
SKP / S 70-16		M16	11,5	14,5	21,5	16,5	23,0	16,0	16,0	46,5	70	-1.7 Kg
SKP / S 95-8	95	M8	13,5	16,5	25,0	8,5	24,0	12,5	12,5	48,0	60	-2.0 Kg
SKP / S 95-10		M10	13,5	16,5	25,0	10,5	24,0	12,5	12,5	48,0	80	-1.9 Kg
SKP / S 95-12		M12	13,5	16,5	25,0	13,0	24,0	12,5	12,5	48,0	80	-1.9 Kg
SKP / S 95-16		M16	13,5	16,5	25,0	16,5	26,0	16,0	16,0	50,5	50	-1.6 Kg
SKP / S 120-8	120	M8	14,5	18,0	27,0	8,5	26,5	14,0	14,0	52,0	50	-2.4 Kg
SKP / S 120-10		M10	14,5	18,0	27,0	10,5	26,5	14,0	14,0	52,0	50	-2.4 Kg
SKP / S 120-12		M12	14,5	18,0	27,0	13,0	26,5	14,0	14,0	52,0	50	-2.4 Kg
SKP / S 120-16		M16	14,5	18,0	27,0	16,5	26,5	14,0	14,0	52,0	50	-1.8 Kg
SKP / S 150-8	150	M8	16,5	21,0	29,0	8,5	30,5	15,0	15,0	57,0	30	-2.5 Kg
SKP / S 150-10		M10	16,5	21,0	29,0	10,5	30,5	15,0	15,0	57,0	40	-2.5 Kg
SKP / S 150-12		M12	16,5	21,0	29,0	13,0	30,5	15,0	15,0	57,0	40	-2.4 Kg
SKP / S 150-16		M16	16,5	21,0	29,0	16,5	30,5	15,0	15,0	57,0	30	-2.3 Kg
SKP / S 185-10	185	M10	18,5	23,0	33,0	10,5	33,5	16,0	16,0	63,0	20	-1.9 Kg
SKP / S 185-12		M12	18,5	23,0	33,0	13,0	33,5	16,0	16,0	63,0	30	-1.9 Kg
SKP / S 185-16		M16	18,5	23,0	33,0	16,5	33,5	16,0	16,0	63,0	30	-1.8 Kg
SKP / S 240-10	240	M10	21,0	26,0	37,0	10,5	38,0	16,5	16,5	70,0	20	-2.7 Kg
SKP / S 240-12		M12	21,0	26,0	37,0	13,0	38,0	16,5	16,5	70,0	25	-2.7 Kg
SKP / S 240-16		M16	21,0	26,0	37,0	16,5	38,0	16,5	16,5	70,0	25	-2.6 Kg
SKP / S 300-12	300	M12	23,4	28,6	41,0	13,0	42,6	18,0	18,0	95,0	20	-3.5 Kg
SKP / S 300-16		M16	23,4	28,6	41,0	17,0	42,6	18,0	18,0	95,0	20	-3.2 Kg

Diğer kablo kesiti ve metrik ölçüleri için lütfen bizi arayınız.

DIN 46235 NORMU SKP KABLO UCU

Bakır malzemeden kalay kaplı

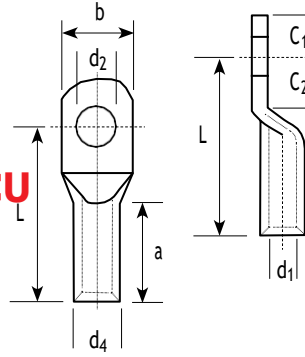

Sipariş Kodu	Kablo Kesiti	Metrik	Ölçüler (mm)								Kutu Adedi	Kutu Ağırlığı
			d1	d4	a	d2	b	c1	c2	L		
SKP / D 10-5	10	M5	4.5	6.0	10.0	5.3	9.0	7.0	8.5	27.0	500	~1.9 Kg
SKP / D 10-6		M6	4.5	6.0	10.0	6.4	9.0	7.5	8.5	27.0	500	~1.8 Kg
SKP / D 10-8		M8	4.5	6.0	10.0	6.4	9.0	7.5	8.5	27.0	500	~1.8 Kg
SKP / D 16-6	16	M6	5.5	8.5	20.0	6.4	13.0	7.5	8.0	36.0	200	~2.4 Kg
SKP / D 16-8		M8	5.5	8.5	20.0	8.4	13.0	10.0	10.0	36.0	200	~2.4 Kg
SKP / D 16-10		M10	5.5	8.5	20.0	10.5	17.0	12.0	12.0	36.0	200	~2.4 Kg
SKP / D 25-6	25	M6	7.0	10.0	20.0	6.4	14.0	7.5	8.0	38.0	175	~2.6 Kg
SKP / D 25-8		M8	7.0	10.0	20.0	8.4	16.0	10.0	10.0	38.0	175	~2.8 Kg
SKP / D 25-10		M10	7.0	10.0	20.0	10.5	17.0	12.0	12.0	38.0	175	~2.8 Kg
SKP / D 25-12		M12	7.0	10.0	20.0	13.0	19.0	13.0	13.0	38.0	150	~2.3 Kg
SKP / D 35-8	35	M8	8.2	12.5	20.0	8.4	17.0	10.0	10.0	42.0	100	~2.8 Kg
SKP / D 35-10		M10	8.2	12.5	20.0	10.5	19.0	12.0	12.0	42.0	100	~2.8 Kg
SKP / D 35-12		M12	8.2	12.5	20.0	13.0	21.0	13.0	13.0	42.0	100	~2.8 Kg
SKP / D 50-8	50	M8	10.0	14.5	28.0	8.4	20.0	10.0	10.0	52.0	60	~2.7 Kg
SKP / D 50-10		M10	10.0	14.5	28.0	10.5	22.0	12.0	12.0	52.0	60	~2.7 Kg
SKP / D 50-12		M12	10.0	14.5	28.0	13.0	24.0	13.0	13.0	52.0	60	~2.7 Kg
SKP / D 50-16		M16	10.0	14.5	28.0	17.0	28.0	16.0	16.0	52.0	60	~2.7 Kg
SKP / D 70-8	70	M8	11.5	16.5	28.0	8.4	24.0	10.0	10.0	55.0	50	~3.0 Kg
SKP / D 70-10		M10	11.5	16.5	28.0	10.5	24.0	12.0	12.0	55.0	50	~3.1 Kg
SKP / D 70-12		M12	11.5	16.5	28.0	13.0	24.0	13.0	13.0	55.0	50	~3.0 Kg
SKP / D 70-16		M16	11.5	16.5	28.0	17.0	30.0	16.0	16.0	55.0	50	~3.0 Kg
SKP / D 95-8	95	M8	13.5	19.0	35.0	8.4	28.0	12.0	12.0	65.0	35	~3.3 Kg
SKP / D 95-10		M10	13.5	19.0	35.0	10.5	28.0	12.0	12.0	65.0	35	~3.2 Kg
SKP / D 95-12		M12	13.5	19.0	35.0	13.0	28.0	13.0	13.0	65.0	35	~3.2 Kg
SKP / D 95-16		M16	13.5	19.0	35.0	17.0	32.0	16.0	16.0	65.0	35	~3.2 Kg
SKP / D 120-10	120	M10	15.5	21.0	35.0	10.5	32.0	15.0	16.0	70.0	30	~3.4 Kg
SKP / D 120-12		M12	15.5	21.0	35.0	13.0	32.0	16.0	17.0	70.0	30	~3.4 Kg
SKP / D 120-16		M16	15.5	21.0	35.0	17.0	32.0	19.0	20.0	70.0	30	~3.4 Kg
SKP / D 120-20		M20	15.5	21.0	35.0	21.0	32.0	21.0	22.0	70.0	30	~3.4 Kg
SKP / D 150-10	150	M10	17.0	23.5	35.0	10.5	34.0	15.0	16.0	78.0	15	~2.5 Kg
SKP / D 150-12		M12	17.0	23.5	35.0	13.0	34.0	16.0	17.0	78.0	15	~2.5 Kg
SKP / D 150-16		M16	17.0	23.5	35.0	17.0	34.0	19.0	20.0	78.0	15	~2.5 Kg
SKP / D 150-20		M20	17.0	23.5	35.0	21.0	40.0	21.0	22.0	78.0	15	~2.5 Kg
SKP / D 185-10	185	M10	19.0	25.5	40.0	10.5	37.0	15.0	16.0	82.0	12	~2.3 Kg
SKP / D 185-12		M12	19.0	25.5	40.0	13.0	37.0	16.0	17.0	82.0	12	~2.3 Kg
SKP / D 185-16		M16	19.0	25.5	40.0	17.0	37.0	19.0	20.0	82.0	12	~2.3 Kg
SKP / D 185-20		M20	19.0	25.5	40.0	21.0	40.0	21.0	22.0	82.0	12	~2.2 Kg
SKP / D 240-12	240	M12	21.5	29.0	40.0	13.0	42.0	16.0	17.0	92.0	8	~2.2 Kg
SKP / D 240-16		M16	21.5	29.0	40.0	17.0	42.0	19.0	20.0	92.0	8	~2.2 Kg
SKP / D 240-20		M20	21.5	29.0	40.0	21.0	45.0	21.0	22.0	92.0	8	~2.2 Kg
SKP / D 300-16	300	M16	24.5	24.5	50.0	17.0	48.0	22.0	19.0	100.0	10	~3.4 Kg
SKP / D 300-20		M20	24.5	24.5	50.0	21.0	48.0	22.0	22.0	100.0	10	~3.4 Kg
SKP / D 400-16	400	M16	27.5	38.5	70.0	17.0	55.0	25.0	25.0	115.0	8	~5.3 Kg
SKP / D 400-20		M20	27.5	38.5	70.0	21.0	55.0	25.0	25.0	115.0	8	~5.4 Kg
SKP / D 500-20	500	M20	31.0	42.0	70.0	21.0	60.0	25.0	25.0	125.0	4	~3.4 Kg
SKP / D 625-20	625	M20	34.5	44.0	80.0	21.0	60.0	25.0	25.0	135.0	4	~2.5 Kg

45° SIKMALI KABLO UCU

Bakır malzemeden kalay kaplı

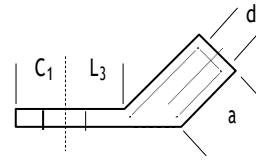
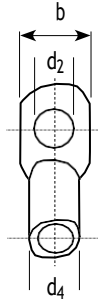

SKP-L45°



Sipariş Kodu	Kablo Kesiti	Metrik	Ölçüler (mm)							Kutu Adedi	Kutu Ağırlığı
			d1	d4	a	d2	b	c1	L3		
SKP / L45 6-5	6	M5	3.5	6.5	9.0	5.5	10.0	7.5	9.0	600	~3.6 Kg
SKP / L45 6-6		M6	3.5	6.5	9.0	6.5	12.0	7.5	10.0	600	~3.7 Kg
SKP / L45 6-8		M8	3.5	6.5	9.0	8.5	14.0	10.0	13.0	600	~3.8 Kg
SKP / L45 10-5	10	M5	4.5	7.0	10.0	5.5	12.0	6.5	10.0	500	~3.0 Kg
SKP / L45 10-6		M6	4.5	7.0	10.0	6.5	12.0	6.5	10.0	500	~2.9 Kg
SKP / L45 10-8		M8	4.5	7.0	10.0	8.5	15.0	10.0	13.0	400	~2.6 Kg
SKP / L45 16-6	16	M6	5.5	8.5	13.0	6.5	12.0	7.5	10.0	300	~3.1 Kg
SKP / L45 16-8		M8	5.5	8.5	13.0	8.5	15.0	10.0	13.0	250	~3.5 Kg
SKP / L45 16-10		M10	5.5	8.5	13.0	10.5	17.0	12.0	15.0	200	~2.9 Kg
SKP / L45 25-5	25	M5	7.0	10.0	15.0	5.5	14.0	7.5	11.0	200	~2.9 Kg
SKP / L45 25-6		M6	7.0	10.0	15.0	6.5	14.0	7.5	11.0	200	~2.8 Kg
SKP / L45 25-8		M8	7.0	10.0	15.0	8.5	16.0	10.0	13.0	200	~3.0 Kg
SKP / L45 25-10		M10	7.0	10.0	15.0	10.5	18.0	12.0	15.0	150	~3.4 Kg
SKP / L45 25-12		M12	7.0	10.0	15.0	13.0	19.0	13.0	18.0	150	~3.1 Kg
SKP / L45 35-6	35	M6	8.5	12.0	17.0	8.5	17.0	10.0	13.0	125	~2.9 Kg
SKP / L45 35-8		M8	8.5	12.0	17.0	10.5	19.0	12.0	15.0	100	~2.9 Kg
SKP / L45 35-10		M10	8.5	12.0	17.0	13.0	21.0	13.0	18.0	80	~2.4 Kg
SKP / L45 35-12		M12	8.5	12.0	17.0	17.0	26.0	16.0	22.0	80	~2.4 Kg
SKP / L45 50-6	50	M6	10.0	14.0	19.0	6.5	20.0	10.0	13.0	80	~2.8 Kg
SKP / L45 50-8		M8	10.0	14.0	19.0	8.5	20.0	10.0	13.0	80	~2.7 Kg
SKP / L45 50-10		M10	10.0	14.0	19.0	10.5	20.0	12.0	16.0	80	~2.7 Kg
SKP / L45 50-12		M12	10.0	14.0	19.0	13.0	23.0	13.0	18.0	70	~2.7 Kg
SKP / L45 70-8	70	M8	12.0	16.5	21.0	8.5	23.0	10.0	13.0	60	~3.2 Kg
SKP / L45 70-10		M10	12.0	16.5	21.0	10.5	23.0	10.0	14.0	60	~3.1 Kg
SKP / L45 70-12		M12	12.0	16.5	21.0	13.0	23.0	12.0	16.0	60	~3.1 Kg
SKP / L45 95-8	95	M8	13.5	18.0	25.0	8.5	26.0	12.0	14.0	40	~3.0 Kg
SKP / L45 95-10		M10	13.5	18.0	25.0	10.5	26.0	12.0	17.0	40	~2.5 Kg
SKP / L45 95-12		M12	13.5	18.0	25.0	13.0	26.0	13.0	18.0	40	~2.5 Kg
SKP / L45 95-16		M16	13.5	18.0	25.0	17.0	28.0	16.0	22.0	40	~1.9 Kg
SKP / L45 120-8	120	M8	15.0	19.5	26.0	8.5	28.0	14.0	16.0	30	~2.3 Kg
SKP / L45 120-10		M10	15.0	19.5	26.0	10.5	28.0	14.0	17.0	30	~2.3 Kg
SKP / L45 120-12		M12	15.0	19.5	26.0	13.0	28.0	14.0	18.0	30	~2.2 Kg
SKP / L45 120-16		M16	15.0	19.5	26.0	17.0	30.0	16.0	22.0	30	~2.2 Kg
SKP / L45 150-8	150	M8	16.5	21.0	30.0	8.5	31.0	14.0	16.0	25	~2.2 Kg
SKP / L45 150-10		M10	16.5	21.0	30.0	10.5	31.0	14.0	17.0	25	~2.2 Kg
SKP / L45 150-12		M12	16.5	21.0	30.0	13.0	31.0	14.0	18.0	25	~2.2 Kg
SKP / L45 150-16		M16	16.5	21.0	30.0	17.0	31.0	16.0	22.0	25	~2.2 Kg
SKP / L45 150-20		M20	16.5	21.0	30.0	21.0	36.0	22.0	24.0	25	~2.3 Kg
SKP / L45 185-10	185	M10	19.0	24.0	30.0	10.5	35.0	18.0	22.0	20	~2.5 Kg
SKP / L45 185-12		M12	19.0	24.0	30.0	13.0	35.0	18.0	22.0	20	~2.5 Kg
SKP / L45 185-16		M16	19.0	24.0	30.0	17.0	35.0	18.0	22.0	20	~2.4 Kg
SKP / L45 185-20		M20	19.0	24.0	30.0	21.0	39.0	22.0	24.0	20	~2.4 Kg



90° SIKMALI KABLO UCU

Bakır malzemeden kalay kaplı

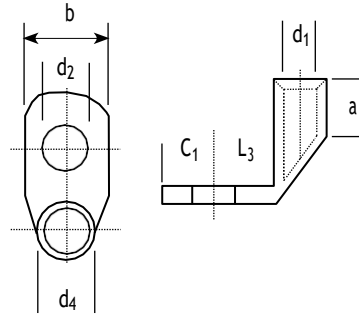

Sipariş Kodu	Kablo Kesiti	Metrik	Ölçüler (mm)							Kutu Adedi	Kutu Ağırlığı
			d1	d4	a	d2	b	c1	L3		
SKP / L90 6-5	6	M5	3,5	6,5	13,0	6,5	12,0	7,5	10,0	600	~3.6 Kg
SKP / L90 6-6		M6	3,5	6,5	13,0	8,5	14,0	10,0	13,0	600	~3.7 Kg
SKP / L90 6-8		M8	3,5	6,5	13,0	10,5	17,0	12,0	15,0	600	~3.8 Kg
SKP / L90 10-5	10	M5	4,5	7,0	14,0	6,5	12,0	6,5	10,0	500	~3.0 Kg
SKP / L90 10-6		M6	4,5	7,0	14,0	8,5	15,0	10,0	13,0	500	~2.9 Kg
SKP / L90 10-8		M8	4,5	7,0	14,0	10,5	17,0	12,0	15,0	400	~2.6 Kg
SKP / L90 16-5	16	M5	5,5	8,5	17,0	6,5	12,0	7,5	11,0	300	~3.2 Kg
SKP / L90 16-6		M6	5,5	8,5	17,0	8,5	15,0	10,0	13,0	300	~3.1 Kg
SKP / L90 16-8		M8	5,5	8,5	17,0	10,5	17,0	12,0	15,0	300	~3.5 Kg
SKP / L90 16-10		M10	5,5	8,5	17,0	13,0	19,0	13,0	18,0	250	~2.9 Kg
SKP / L90 25-5	25	M5	7,0	10,0	19,0	6,5	14,0	7,5	11,0	200	~2.9 Kg
SKP / L90 25-6		M6	7,0	10,0	19,0	8,5	16,0	10,0	13,0	200	~2.8 Kg
SKP / L90 25-8		M8	7,0	10,0	19,0	10,5	18,0	12,0	15,0	200	~3.0 Kg
SKP / L90 25-10		M10	7,0	10,0	19,0	13,0	19,0	13,0	18,0	200	~3.4 Kg
SKP / L90 25-12		M12	8,5	12,0	23,0	6,5	17,0	7,5	11,0	200	~3.1 Kg
SKP / L90 35-6	35	M6	8,5	12,0	23,0	10,5	19,0	12,0	15,0	125	~2.9 Kg
SKP / L90 35-8		M8	8,5	12,0	23,0	13,0	21,0	13,0	18,0	125	~2.9 Kg
SKP / L90 35-10		M10	8,5	12,0	23,0	17,0	26,0	16,0	22,0	100	~2.4 Kg
SKP / L90 35-12		M12	10,0	14,0	25,0	6,5	20,0	10,0	13,0	100	~2.4 Kg
SKP / L90 50-6	50	M6	10,0	14,0	25,0	8,5	20,0	10,0	13,0	80	~2.8 Kg
SKP / L90 50-8		M8	10,0	14,0	25,0	10,5	20,0	12,0	16,0	80	~2.7 Kg
SKP / L90 50-10		M10	10,0	14,0	25,0	13,0	23,0	13,0	18,0	80	~2.7 Kg
SKP / L90 50-12		M12	10,0	14,0	25,0	17,0	28,0	16,0	22,0	80	~2.7 Kg
SKP / L90 70-8	70	M8	12,0	16,5	29,0	8,5	23,0	10,0	14,0	60	~3.2 Kg
SKP / L90 70-10		M10	12,0	16,5	29,0	10,5	23,0	12,0	16,0	60	~3.1 Kg
SKP / L90 70-12		M12	12,0	16,5	29,0	13,0	23,0	13,0	18,0	60	~3.1 Kg
SKP / L90 95-8	95	M8	13,5	18,0	33,0	10,5	26,0	12,0	17,0	50	~3.0 Kg
SKP / L90 95-10		M10	13,5	18,0	33,0	13,0	26,0	13,0	18,0	40	~2.5 Kg
SKP / L90 95-12		M12	13,5	18,0	33,0	17,0	28,0	16,0	22,0	40	~2.5 Kg
SKP / L90 95-16		M16	13,5	18,0	33,0	21,0	36,0	22,0	24,0	30	~1.9 Kg
SKP / L90 120-8	120	M8	15,0	19,5	36,0	10,5	28,0	14,0	17,0	30	~2.3 Kg
SKP / L90 120-10		M10	15,0	19,5	36,0	13,0	28,0	14,0	18,0	30	~2.3 Kg
SKP / L90 120-12		M12	15,0	19,5	36,0	17,0	30,0	16,0	22,0	30	~2.2 Kg
SKP / L90 120-16		M16	15,0	19,5	36,0	21,0	36,0	22,0	24,0	30	~2.2 Kg
SKP / L90 150-8	150	M8	16,5	21,0	40,0	10,5	31,0	14,0	17,0	25	~2.2 Kg
SKP / L90 150-10		M10	16,5	21,0	40,0	13,0	31,0	15,0	18,0	25	~2.2 Kg
SKP / L90 150-12		M12	16,5	21,0	40,0	17,0	31,0	16,0	22,0	25	~2.2 Kg
SKP / L90 150-16		M16	16,5	21,0	40,0	21,0	36,0	22,0	24,0	25	~2.2 Kg
SKP / L90 150-20		M20	19,0	24,0	42,0	10,5	35,0	18,0	22,0	25	~2.3 Kg
SKP / L90 185-10	185	M10	19,0	24,0	42,0	13,0	35,0	18,0	22,0	20	~2.5 Kg
SKP / L90 185-12		M12	19,0	24,0	42,0	17,0	35,0	18,0	22,0	20	~2.5 Kg
SKP / L90 185-16		M16	19,0	24,0	42,0	21,0	39,0	22,0	24,0	20	~2.4 Kg
SKP / L90 185-20		M20	21,0	26,0	45,0	10,5	39,0	21,5	22,0	20	~2.4 Kg

TERMİNALLER

YASSI GEÇME TİP DİŞİ - ERKEK TERMİNALLER

Sipariş Kodu	AÇIKLAMA	Kutu Adedi
SF-1D	6,3 Dişi Terminal	300
SF-2D	6,3 Dişi Terminal Tırnaklı	300
SF-3D	9,5 Dişi Terminal	100
SF-1/2 D	2,8 Dişi Terminal	1.000
SF-1D	4,8 Mini Dişi Terminal	500
SF-1D	6,3 RÇN-DÇN Çelik Terminal	300
SF-1D	6,3 Eğri Dişi Terminal	250
SF-1D	4,8 Mini Eğri Dişi Terminal	400
SF-2.5 D	7,7 Eğri Dişi Terminal	200
SF-3D	9,5 Eğri Terminal	100
SF-1D E	6,3 Dişi-Erkek Terminal	100

YASSI GEÇME TİP DİŞİ - ERKEK TERMİNALLER

SF-1E ÇK	6,3 Erkek Terminal	300
SF-1EU1	6,3 Erkek Terminal	300
SKN-1/2	4,8 Erkek Terminal	500

TOPRAKLAMA TİPİ TERMİNALLER

SK-2.5	04 Topraklama Tipi Terminal	1.000
SK-4	05 Topraklama Tipi Terminal	500
SK-6	06 Topraklama Tipi Terminal	250

DELİKLİ TİP TOPRAKLAMA TERMİNALLERİ

SW-4	03/04 Topraklama Terminal	1.000
SKN-1	03/04 Topraklama Terminal	500
SKN-2.5	04/05/06 Topraklama Terminal	400
SKN-4	04/05/06 Topraklama Terminal	250
SKN-6	06/08 Topraklama Terminal	150
SKN-10	08/10/12/13 Topraklama Terminal	100

ÇATAL TİP TOPRAKLAMA TERMİNALLERİ

SKN-1C	Çatal Tip Top. Terminali	750
SKN-2.5C	Çatal Tip Top. Terminali	500
SKN-4C	Çatal Tip Top. Terminali	250
SKN-6C	Çatal Tip Top. Terminali	150

DİŞİ GEÇMELİ TİP TERMİNALLER

SF-4D	Dişi Geçmeli Tip Terminal	300
SF-4E	Erkek Geçmeli Tip Terminal	300
SF-4D O	Dişi Geçmeli Tip Terminal	300
SF-4E O	Erkek Geçmeli Tip Terminal	300

YASSI GEÇME TİP ERKEK TERMİNALLER

SFK-1	1-04 (6.3) Top Erkek Terminal	1.000
SFK-4	4-03 (4.8) Top Erkek Terminal	1.000
SFK-25	Kart Tip Erkek Terminal 6.3	1.000
SFK-35	Kart Tip Erkek Terminal 6.3	1.000
SFK-39	Kart Tip Erkek Terminal 6.3	1.000
SFK-43	Kart Tip Erkek Terminal 6.3	1.000
SFK-25	MiniKart Tip Erkek Terminal 4.8	1.000

RPK TİP TERMİNALLER

SF-22	Erkek Terminal RPK	4.000
SF-22	Dişi Terminal RPK	4.000

YASSI GEÇME TİP DİŞİ TERMİNALLER

SF-1D	Mini DÇN Terminal	500
SF-1D	1D B Dişi Terminal	300
SF-1D	1D K Dişi Terminal	300
SF-W	W Buji Kablo Ucu	100



TERMİNAL VE KONNEKTÖRLER

TERMİNAL KILIFLARI

Sipariş Kodu	AÇIKLAMA	Kutu Adedi	t
SF-1D	Terminal Kılıfı (PE)	300	
SF-2D	Mini Terminal Kılıfı (PE)	250	
SF-3D	Terminal Kılıfı (PE)	100	
SF-1D	Terminal Kılıfı (PVC)	300	
SF-4D	Terminal Kılıfı (PE)	100	
SF-1E	Terminal Kılıfı (PE)	500	



KONNEKTÖRLER

SF-1D	Eğri Konnektör	250
SF-2D	R Tipi 6.3 Konnektör	300
MİNİ	R Tipi 4.8 Konnektör	500
SF-1/2D	R Tipi 2.8 Konnektör	1.000

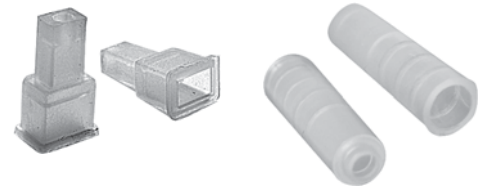

ERKEK VE DIŞI KONNEKTÖRLER

101	1'li Erkek Konnektör	100
102	1'li Dişi Konnektör	100
201	2'li Erkek Konnektör	100
202	2'li Dişi Konnektör	100
301	3 'lü Erkek Konnektör	100
302	3 'lü Dişi Konnektör	100
401	4'lü Erkek Konnektör	100
402	4 'lü Dişi Konnektör	100
601	6'lı Erkek Konnektör	100
602	6'lı Dişi Konnektör	100
801	8'li Erkek Konnektör	100
802	8'li Dişi Konnektör	100

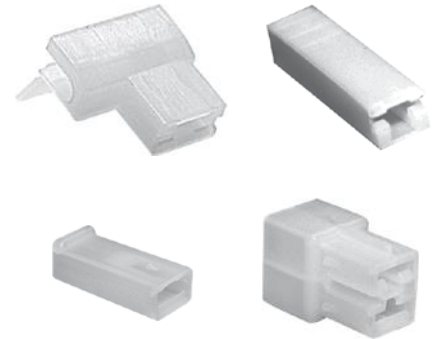

AÇIK TİP BAKIR KABLO UÇLARI

BA-10	Bakır Top. Kablo Ucu	100
BA-16	Bakır Top. Kablo Ucu	100
BA-25	Bakır Top. Kablo Ucu	100
BA-35	Bakır Top. Kablo Ucu	50
BA-50	Bakır Top. Kablo Ucu	25
BA-70	Bakır Top. Kablo Ucu	25



BA-25

BA-50

BK-70

KAPALI TİP BAKIR KABLO UÇLARI

BK-10	Bakır Top. Kablo Ucu	1.000
BK-16	Bakır Top. Kablo Ucu	1.000
BK-25	Bakır Top. Kablo Ucu	1.000
BK-35	Bakır Top. Kablo Ucu	1.000
BK-50	Bakır Top. Kablo Ucu	1.000
BK-70	Bakır Top. Kablo Ucu	500



BK-6-6

BK-6-35

BK-10-35

MONOFAZE ERKEK İZOLELİ BARALAR

Sipariş Kodu	Modül	Bakır Kalınlığı	Amper	Kutu Adedi
MON - 30 / 1,0	30 Otomat için	1,0 mm	80 A	30
MON - MT / 1,0	56 Otomat için	1,0 mm	80 A	30
MON - 30 / 1,5	30 Otomat için	1,5 mm	100 A	30
MON - MT / 1,5	56 Otomat için	1,5 mm	100 A	30



İKİ FAZLI ERKEK İZOLELİ BARALAR

Sipariş Kodu	Modül	Bakır Kalınlığı	Amper	Kutu Adedi
DİF - 15 / 1,0	15 Grup için	1,0 mm	80 A	12
DİF - MT / 1,0	28 Grup için	1,0 mm	80 A	10
DİF - 15 / 1,5	15 Grup için	1,5 mm	100 A	12
DİF - MT / 1,5	28 Grup için	1,5 mm	100 A	10



TRİFAZE ERKEK İZOLELİ BARALAR

Sipariş Kodu	Modül	Bakır Kalınlığı	Amper	Kutu Adedi
TRİ - 02 / 1,0	2 Grup için	1,0 mm	80 A	50
TRİ - 04 / 1,0	4 Grup için	1,0 mm	80 A	20
TRİ - 06 / 1,0	6 Grup için	1,0 mm	80 A	10
TRİ - 08 / 1,0	8 Grup için	1,0 mm	80 A	10
TRİ - 10 / 1,0	10 Grup için	1,0 mm	80 A	10
TRİ - MT / 1,0	19 Grup için	1,0 mm	80 A	8
TRİ - 20 / 1,0	20 Grup için	1,0 mm	80 A	8
TRİ - 38 / 1,0	38 Grup için	1,0 mm	80 A	8
TRİ - 02 / 1,5	2 Grup için	1,5 mm	100 A	50
TRİ - 04 / 1,5	4 Grup için	1,5 mm	100 A	20
TRİ - 06 / 1,5	6 Grup için	1,5 mm	100 A	10
TRİ - 08 / 1,5	8 Grup için	1,5 mm	100 A	10
TRİ - 10 / 1,5	10 Grup için	1,5 mm	100 A	10
TRİ - MT / 1,5	19 Grup için	1,5 mm	100 A	8
TRİ - 20 / 1,5	20 Grup için	1,5 mm	100 A	8
TRİ - 38 / 1,5	38 Grup için	1,5 mm	100 A	8



Sipariş Kodu	Kutu Adedi
MONOFAZE BARA TAPASI	300
TRİFAZE BARA TAPASI	250



NÖTR VİDALI TOPRAKLAMA BARALARI

Sipariş Kodu	Modül	Bakır Kalınlığı	Kutu Adedi
TOP/B - 1,5 / 31	31 Vida	1,5 x 15.0	10
TOP/B - 1,5 / 61	61 Vida	1,5 x 15.0	10
TOP/B - 2,0 / 31	31 Vida	2,0 x 15.0	10
TOP/B - 2,0 / 61	61 Vida	2,0 x 15.0	10
TOP/B - 3,0 / 31	31 Vida	3,0 x 15.0	10
TOP/B - 3,0 / 61	61 Vida	3,0 x 15.0	10



TOPRAKLAMA BARALARI



MODÜLER GÜÇ KLEMENSLERİ (TRİFAZE - MONOFAZE - DİFAZE BAĞLANTI KLEMENSİ)

Sipariş Kodu	3061	3065	FTG-802/115 S	FTG-802/215 S	FTG-802/114	FTG-MSV GE 1-14
Cinsi	No.1 (2.5 - 10 mm ²)	No.2 (16 - 25 mm ²)	No.3 (6 - 25 mm ²)	No.3 (6 - 50 mm ²)	No.2(6-25 mm ²) Çatal uçlu	No.3 (6 - 50 mm ²) Çatal uçlu, Uçlu
Kutu Adedi	150	100	30	25	25	1

LVT Test Laboratuvarları Ltd. Şti.

AB-0041-T
LVT-D.15-0190-R.01
04-15

3/30

1. Numunelerin Tanımı
Definition of the Samples

1.1 TRİFAZE WİTOMAT BARASI (TRİ-MT / 1.0 mm 3.FAZ) (LVT-D.15-0190-R.01-01)
(LVT-D.15-0289-R.00-01)

Numune Kabul Tarihi / Date of Receipt: 02.03.2015
Kutup Sayısı / Number of Poles: 3 Faz + Nötr
Beyan Gerilimi / Rated Voltage: U_n : 400 V
Araç Devresi / Rated Inverter Voltage: U_{in} : 6.0 kV
Beyan Darbe Dayanım Gerilimi / Rated Surge Withstand Voltage: U_{imp} : 6.0 kV
Beyan Akım / Rated Current: I_n : 80 A
Beyan Frekansı / Rated Frequency: f_n : 50 Hz
Bata Kesit / Busbar Section: mm² : 1.0
Boya - Kaplama Özellikleri / Paint - Coating Properties: 1 Rız. Sayfa: 21-25
Kritik Deneysel Prosedür Sayısı / Critical Experimental Procedure Number: 3 - (Malzeme grubu ile)
Çizim - Malzeme Listesi / Drawing - Component List: 1 -

1.1 TRİFAZE WİTOMAT BARASI (TRİ-MT / 1.0 mm 3.FAZ) (LVT-D.15-0211-R.01-01)
(LVT-D.15-0211-R.00-01)

Numune Kabul Tarihi / Date of Receipt: 02.03.2015
Kutup Sayısı / Number of Poles: 3 Faz + Nötr
Beyan Gerilimi / Rated Voltage: U_n : 400 V
Araç Devresi / Rated Inverter Voltage: U_{in} : 6.0 kV
Beyan Darbe Dayanım Gerilimi / Rated Surge Withstand Voltage: U_{imp} : 6.0 kV
Beyan Akım / Rated Current: I_n : 100 A
Beyan Frekansı / Rated Frequency: f_n : 50 Hz
Bata Kesit / Busbar Section: mm² : 1.5
Boya - Kaplama Özellikleri / Paint - Coating Properties: 1 Rız. Sayfa: 26-30
Kritik Deneysel Prosedür Sayısı / Critical Experimental Procedure Number: 3 - (Malzeme grubu ile)
Çizim - Malzeme Listesi / Drawing - Component List: 1 -

FRS2 / REV04

LVT Test Laboratuvarları Ltd. Şti.

AB-0041-T
LVT-D.15-0190-R.01
04-15

4/30

2. Deneysel Sonuçlar
Test Results

1 Deneysel sonuçlar, aşağıdaki deney raporları numarelere aittir:
The results are not belong to the tested samples

Numune / Sample	Uygulanan Deney / Applied Test	Sonuç / Result
TRİFAZE WİTOMAT BARASI (TRİ-MT / 1.0 mm 3.FAZ)	Diyetrik Ölçümler	OLUMLU
TRİFAZE WİTOMAT BARASI (TRİ-MT / 1.0 mm 3.FAZ)	Sıcaklık Doğrulaması (80 A)	OLUMLU
TRİFAZE WİTOMAT BARASI (TRİ-MT / 1.0 mm 3.FAZ)	Sıcaklık Doğrulaması (100 A)	OLUMLU
TRİFAZE WİTOMAT BARASI (TRİ-MT / 1.0 mm 3.FAZ)	Yanlış Malzeme Anomalı İyileştirme ve Elektrik Elektronik Etkileşimleri Kaynaklı Yanlış Dayanıklılığa Doğrulaması	OLUMLU
TRİFAZE WİTOMAT BARASI (TRİ-MT / 1.0 mm 3.FAZ)	İçeri Kısa Devre Deneyi (I _{sc})	OLUMLU
TRİFAZE WİTOMAT BARASI (TRİ-MT / 1.0 mm 3.FAZ)	İçeri Kısa Devre Deneyi (I _{sc})	OLUMLU

3. Çevre Şartları
Environmental Conditions

3.1 Ortam Sıcaklığı
Ambient Temperature: 1 (19±3) °C

Ortam Nemli
Relative Humidity: 1 (51±3) %RH

Çalışmalar
Experiments: 2 Deneysel sonuçlar, aşağıdaki deney raporları numarelere aittir.
Test results are not belong to the tested samples.

Ölçüm Belirleme
(Tespit Yöntemleri)
Measurement Method (Not Reported)

7. Açıklama
Explanation: 1 -

8. Dağıtım Bilgileri
Distribution Information: 1 ZU ELEKTRİK ELEKTRONİK SAN. VE TİC. LTD. ŞTİ.

FRS3

BELGELER GELECEK

Lvt
Test Laboratuvarları

LVT Test Laboratuvarları Ltd. Şti.
www.lvt.com.tr
Sarıyazı Modern Kavaklılar Saraylı Kısık 4. Cadde No:9 Faza 1 ANKARA
Tel: 0 312 815 11 72 Faks: 0 312 815 11 74

DENEY RAPORU
Test Report

AB-0041-T
LVT-D.15-0190-R.01
04-15

1/30

Müşteri / Client: 1 ZU ELEKTRİK ELEKTRONİK SAN. VE TİC. LTD. ŞTİ.

Adres / Address: 1 İTTELLİ ÖRG. SAN. BÖL. BARMARA SAN. SİT. E BLOK NO:8 İTTELLİ / İSTANBUL

İmalatçı / Manufacturer: 1 ZU ELEKTRİK ELEKTRONİK SAN. VE TİC. LTD. ŞTİ.

Deneysel Numune / Test Sample: 1 TRİFAZE WİTOMAT BARASI

Marka / Trade Mark: 1 ZU

Deneysel Yöntem / Test Method: 1 TS EN 61438-1:2012, AC:2014, TS:2014

Deneysel Tarihi / Date of Test: 1 10.03.2015 - 18.03.2015

Toplam Sayfa Sayısı / Total Number of Pages: 1 30.

Türk Akademi Bilimler Kurumu (TÜRKAK) deney raporlarının bilimsel konularında Avrupa Akademi Bilimler Birliği (AA) ve Uluslararası Laboratuvar Akademi Bilimler Birliği (ILAC) ile karşılıklı bilimsel anlaşmalar mevcuttur.
The Turkish Accreditation Agency (TÜRKAK) is signatory to the multilateral agreements of the European Association for the Accreditation (EA) and of the International Laboratory Accreditation (ILAC) for the Mutual recognition of calibration certificates.
Deney ve / veya ölçüm sonuçları, gerektirdiği ölçüm belgeleriyle (deney tutanakları) ve deney metotları, bu raporla birlikte bilimsel olarak kabul edilebilir şekilde sunulmaktadır.
The test and / or measurement results, the uncertainties (if required) with confidence probability and test methods are given on the following pages which are part of this report.

Mühür / Seal: 

Tarih / Date: 07/04/2015

Deneysel Sorumlusu / Person in Charge of Test: C. ÖZGÜR

Laboratuvar Müdürü / Head of Testing Laboratory: AB-0041-T

Bu rapor, Laboratuvarımızla paylaşmış olduğumuz bilimsel verilerin doğruluğunu doğrulamaktadır.
This report shall not be reproduced other than as set forth with the permission of the laboratory.
Testing reports without signature and seal are not valid.
FRS2 / REV04



**ISI İLE DARALAN
MAKARON**
沃尔



**ISI İLE DARALAN
MAKARONLAR**

ISI İLE DARALAN MAKARONLAR

Polyolefin mamülden, Halogen-free özellikli, 2/1 oranında daralan, RoHS ISO belgeli, UL sertifikalı.

Ölçüler		Daralmadan Önce (mm)		Daralmadan Sonra (mm)		Makara (m)	
Inc (Ø)	mm	İç Çap	Cıdar Kalınlığı	İç Çap	Cıdar Kalınlığı		
3 / 64	0.8	1,1 ± 0,2	0,15 ± 0,05	0,40	0,28 ± 0,10	200	
	1	1,5 ± 0,2	0,15 ± 0,05	0,50	0,28 ± 0,10	200	
	1.2	2,0 ± 0,2	0,15 ± 0,05	0,70	0,30 ± 0,10	200	
	1.5	2,0 ± 0,2	0,18 ± 0,05	0,85	0,32 ± 0,10	200	
1 / 16	1.6	2,0 ± 0,3	0,15 ± 0,05	0,80	0,28 ± 0,10	200	
	2	2,5 ± 0,2	0,18 ± 0,05	0,60	0,28 ± 0,10	200	
3 / 32	2.4	3,0 ± 0,3	0,18 ± 0,05	1,20	0,35 ± 0,10	200	
	2.5	3,0 ± 0,2	0,18 ± 0,05	1,30	0,38 ± 0,10	200	
	3	3,5 ± 0,2	0,18 ± 0,05	1,50	0,40 ± 0,10	200	
1 / 8	3.2	3,5 ± 0,4	0,18 ± 0,05	1,60	0,40 ± 0,10	200	
	3.5	4,0 ± 0,2	0,22 ± 0,05	1,80	0,42 ± 0,10	200	
	4	4,5 ± 0,2	0,25 ± 0,05	2,00	0,45 ± 0,10	200	
	4.5	5,0 ± 0,2	0,25 ± 0,05	2,30	0,50 ± 0,10	100	
3 / 16	4.8	5,2 ± 0,4	0,25 ± 0,05	2,40	0,50 ± 0,10	100	
	5	5,5 ± 0,2	0,25 ± 0,05	2,50	0,55 ± 0,10	100	
1 / 4	6	6,5 ± 0,2	0,28 ± 0,05	3,00	0,55 ± 0,10	100	
	6.4	7,0 ± 0,4	0,28 ± 0,05	3,20	0,55 ± 0,10	100	
	7	7,5 ± 0,3	0,28 ± 0,05	3,50	0,55 ± 0,10	100	
3 / 8	8	8,5 ± 0,3	0,28 ± 0,05	4,00	0,60 ± 0,10	100	
	9	9,5 ± 0,3	0,30 ± 0,08	4,50	0,60 ± 0,10	50	
	9.5	10,0 ± 0,5	0,30 ± 0,08	4,80	0,60 ± 0,10	100	
	10	10,5 ± 0,3	0,30 ± 0,08	5,00	0,60 ± 0,10	100	
1 / 2	11	11,5 ± 0,3	0,30 ± 0,08	5,50	0,60 ± 0,10	100	
	12	12,5 ± 0,3	0,30 ± 0,08	6,00	0,60 ± 0,10	100	
	12.7	13,0 ± 0,5	0,30 ± 0,08	6,40	0,60 ± 0,10	100	
	13	13,5 ± 0,3	0,35 ± 0,10	6,50	0,65 ± 0,10	100	
3 / 4	14	14,5 ± 0,3	0,35 ± 0,10	7,00	0,65 ± 0,10	100	
	15	15,5 ± 0,3	0,35 ± 0,10	7,00	0,65 ± 0,10	100	
	16	16,5 ± 0,4	0,40 ± 0,12	8,00	0,70 ± 0,10	100	
	17	17,5 ± 0,4	0,40 ± 0,12	8,50	0,70 ± 0,10	100	
4 / 5	18	19,0 ± 0,5	0,40 ± 0,15	9,00	0,80 ± 0,15	100	
	19.1	20,5 ± 0,6	0,40 ± 0,15	9,50	0,80 ± 0,15	100	
1	20	21,0 ± 0,6	0,40 ± 0,15	10,00	0,80 ± 0,15	100	
	22	23,0 ± 0,5	0,40 ± 0,15	11,00	0,80 ± 0,15	100	
1 - 1 / 4	1	25.4	25,6 ± 0,7	0,50 ± 0,15	12,70	0,80 ± 0,15	50
	30	31,5 ± 1,0	0,50 ± 0,15	15,00	0,90 ± 0,15	50	
1 - 1 / 2	32	33,0 ± 0,7	0,50 ± 0,15	15,90	0,95 ± 0,15	50	
	35	36,5 ± 1,0	0,50 ± 0,15	17,50	0,95 ± 0,15	50	
2	38	40,0 ± 0,7	0,50 ± 0,15	19,10	1,00 ± 0,15	50	
	40	41,5 ± 1,0	0,55 ± 0,15	20,00	1,00 ± 0,15	50	
	51	52,5 ± 0,7	0,55 ± 0,15	25,40	0,95 ± 0,15	25	
	60	60	0,60 ± 0,15	30,00	1,30 ± 0,20	25	
3	70	70	0,65 ± 0,15	35,00	1,30 ± 0,20	25	
	76	80,0 ± 1,0	0,65 ± 0,15	38,10	1,30 ± 0,20	25	
	80	80	0,65 ± 0,15	40,00	1,46 ± 0,20	25	
	90	90	0,65 ± 0,15	45,00	1,46 ± 0,20	25	
4	96	100	0,65 ± 0,15	50,00	1,46 ± 0,20	25	
	102	105,0 ± 1,0	0,65 ± 0,20	50,80	1,46 ± 0,20	25	
	5	120	120	0,65 ± 0,20	63,50	1,56 ± 0,20	25
	150	150	0,65 ± 0,20	75,00	1,56 ± 0,20	25	
5	180	180	0,65 ± 0,30	90,00	1,56 ± 0,20	25	
	250	250	0,65 ± 0,30	125,00	1,56 ± 0,20	20	

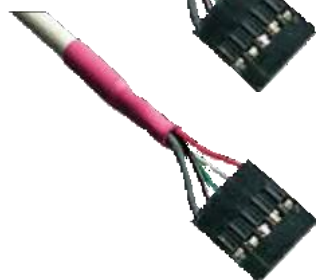
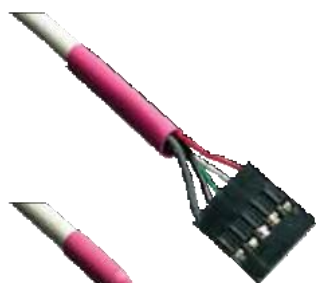

2/1 RENKLİ ISI İLE DARALAN MAKARON

Renkler	Inc	mm	Makara (m)	Kahverengi	Sarı - Yeşil
Beyaz	1/16	1,6	200		
		2,0	200		
	3/32	2,4	200		
		2,5	200		
	1/8	3,2	200		
		3,5	200		
	3/16	4,8	100		
		5	100		
Sarı	1/4	6,4	100		
		7	100		
Mavi	3/8	9,5	100		
		10	100		
		12	100		
	1/2	12,7	100		
Kırmızı		16	100		
	3/4	19,1	100		
Yeşil	4/5	20	100		
	1	25,4	50		
	1-1/4	32	50		
		35	50		
Şeffaf	1-1/2	38	50		
		40	40		
Gri	2	51	50		
		60	25		
		70	25		
	3	76	25		
		96	25		
	4	102	25		
	5	120	25		
		150	25		
		180	25		



Polyolefin mamülden, Halogen-free özellikli, 2/1 oranında daralanan makaron, RoHS ISO belgeli, UL sertifikalı.

3/1 İÇİ YAPIŞKANLI ISI İLE DARALAN MAKARON

Ölçü (mm)	Daralmadan Önce (mm)		Yapışkan Katmanı	Daralmadan Sonra (mm)		Makara (m)
	İç Çap (mm)	Cidar Kalınlığı		İç Çap (mm)	Cidar Kalınlığı	
3.2	3	0,95 ± 0,10	0,35	1,00 ± %10	0,95 ± 0,10	200 m
4.8	4.8	1,10 ± 0,10	0,40	1,60 ± %10	1,10 ± 0,10	100 m
6.4	6.2	1,20 ± 0,10	0,45	2,00 ± %10	1,20 ± 0,10	100 m
9.5	9.5	1,45 ± 0,10	0,50	3,15 ± %10	1,45 ± 0,25	50 m
12.7	12.5	1,60 ± 0,20	0,50	4,16 ± %10	2,45 ± 0,25	1.22Boy
16	16	1,45 ± 0,20	0,35	5,30 ± %10	1,75 ± 0,25	1.22Boy
19.1	19	1,50 ± 0,20	0,40	6,30 ± %10	1,90 ± 0,25	1.22Boy
25.4	25	2,00 ± 0,20	0,45	8,50 ± %10	1,45 ± 0,25	1.22Boy
28	28	2,00 ± 0,20	0,50	9,00 ± %10	2,70 ± 0,25	1.22Boy
30	30	2,00 ± 0,20	0,50	10,0 ± %10	2,70 ± 0,25	1.22Boy
33	33	2,20 ± 0,20	0,50	11,0 ± %10	2,70 ± 0,25	1.22Boy
40	40	2,20 ± 0,20	0,50	13,30 ± %10	2,70 ± 0,25	1.22Boy
44	44	2,30 ± 0,25	0,50	16,60 ± %10	2,80 ± 0,30	1.22Boy
52	52	2,30 ± 0,25	0,50	18,00 ± %10	2,80 ± 0,30	1.22Boy
70	70	2,60 ± 0,25	0,50	24,00 ± %10	3,00 ± 0,30	1.22Boy
90	90	3,10 ± 0,30	0,60	30,00 ± %10	3,70 ± 0,35	1.22Boy
125	125	3,15 ± 0,30	0,60	42,00 ± %10	3,75 ± 0,35	1.22Boy



Polyolefin mamülden, Halogen-free özellikli, 3/1 oranında içi yapışkanlı daralanan makaron, RoHS ISO belgeli, UL sertifikalı.

FG - VG 2500 2.5 kV CAM ELYAF MAKARONLAR

Sipariş Kodu	Çap (mm)	Renkler	Rulo (m)
FG-VG 0.70	0.70	Beyaz Üzeri Çizgili-Siyah	100
FG-VG 1.00	1.00	Beyaz Üzeri Çizgili-Siyah	100
FG-VG 1.50	1.50	Beyaz Üzeri Çizgili-Siyah	100
FG-VG 2.00	2.00	Beyaz Üzeri Çizgili-Siyah	100
FG-VG 2.50	2.50	Beyaz Üzeri Çizgili-Siyah	100
FG-VG 3.00	3.00	Beyaz Üzeri Çizgili-Siyah	100
FG-VG 4.00	4.00	Beyaz Üzeri Çizgili-Siyah	100
FG-VG 5,00	5,00	Beyaz Üzeri Çizgili-Siyah	100
FG-VG 6.00	6.00	Beyaz Üzeri Çizgili-Siyah	50
FG-VG 7.00	7.00	Beyaz Üzeri Çizgili-Siyah	50
FG-VG 8.00	8.00	Beyaz Üzeri Çizgili-Siyah	50
FG-VG 10.00	10.00	Beyaz Üzeri Çizgili-Siyah	50
FG-VG 12.00	12.00	Beyaz Üzeri Çizgili-Siyah	50
FG-VG 14.00	14.00	Beyaz Üzeri Çizgili-Siyah	50
FG-VG 16.00	16.00	Beyaz Üzeri Çizgili-Siyah	50
FG-VG 18.00	18.00	Beyaz Üzeri Çizgili-Siyah	50
FG-VG 20.00	20.00	Beyaz Üzeri Çizgili-Siyah	25
FG-VG 25.00	25.00	Beyaz Üzeri Çizgili-Siyah	25

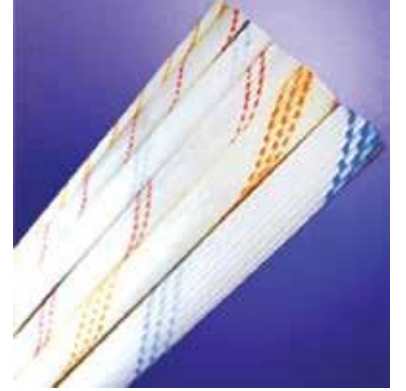

İzolasyon Sınıfı : 8
Çalışma Sıcaklığı : -25 °C / 130 °C

FG - SRG 2.5 kV H CLASS CAM - SİLİKON MAKARONLAR

Sipariş Kodu	Çap (mm)	Renkler	Rulo (m)
FG-SRG 0.70	0.70	Kırmızı - Siyah	100
FG-SRG 1.00	1.00	Kırmızı - Siyah	100
FG-SRG 1.50	1.50	Kırmızı - Siyah	100
FG-SRG 2.00	2.00	Kırmızı - Siyah	100
FG-SRG 2.50	2.50	Kırmızı - Siyah	100
FG-SRG 3.00	3.00	Kırmızı - Siyah	100
FG-SRG 4.00	4.00	Kırmızı - Siyah	100
FG-SRG 5,00	5,00	Kırmızı - Siyah	100
FG-SRG 6.00	6.00	Kırmızı - Siyah	100
FG-SRG 7.00	7.00	Kırmızı - Siyah	100
FG-SRG 8.00	8.00	Kırmızı - Siyah	100
FG-SRG 10.00	10.00	Kırmızı - Siyah	100
FG-SRG 12.00	12.00	Kırmızı - Siyah	50
FG-SRG 14.00	14.00	Kırmızı - Siyah	50
FG-SRG 16.00	16.00	Kırmızı - Siyah	50
FG-SRG 18.00	18.00	Kırmızı - Siyah	50
FG-SRG 20.00	20.00	Kırmızı - Siyah	25
FG-SRG 25.00	25.00	Kırmızı - Siyah	25



İzolasyon Sınıfı : H Class
Çalışma Sıcaklığı : -60 °C / 230 °C



Polyester mamulden monoflam örgülü geniş bir sıcaklık aralığı, kimyasal bozulmaya karşı dirençli, UV, radyasyon ve aşınmaya karşı dayanıklıdır. Kablo çorabı sıcak bir bıçak ile kolayca ve temiz kesilebilir. Kapladığı materyali dış etkenlerden korurken estetik bir görünüm sağlar. UL 94V-0 normunda kendi kendine SÖNDÜRME özelliğine sahiptir.

KABLOTOPLAMAÇORABI

Sipariş Kodu	Min. Tutma Çapı	Max. Tutma Çapı	Rulo (m)	Renk	Renkli
PE - HB 3 - 8	3	8	100	● ●	● ● ●
PE - HB 5 - 10	5	10	100	● ●	● ● ●
PE - HB 6 - 11	6	11	100	● ●	● ● ●
PE - HB 8 - 12	8	12	100	● ●	● ● ●
PE - HB 10 - 15	10	15	100	● ●	● ● ●
PE - HB 12 - 19	12	19	100	● ●	● ● ●
PE - HB 15 - 27	15	27	100	● ●	● ● ●
PE - HB 20 - 28	20	28	100	● ●	● ● ●
PE - HB 25 - 34	25	34	100	● ●	● ● ●
PE - HB 30 - 37	30	37	100	● ●	● ● ●
PE - HB 40 - 45	40	45	100	● ●	● ● ●
PH - HB 50 - 65	50	65	100	● ●	● ● ●



YENİ

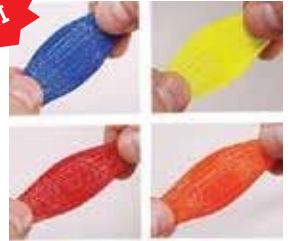

HTG 410 CAM MAKARON (800V)

Sipariş Kodu	İç Çap (mm)	Rulo (m)
HTG-410 / 0.70	0,70 mm ±0,20	100
HTG-410 / 1.0	1 mm ±0,20	100
HTG-410 / 2.0	2,0 mm ±0,30	100
HTG-410 / 2.5	2,5 mm ±0,30	100
HTG-410 / 3.0	3 mm ±0,30	100
HTG-410 / 4.0	4 mm ±0,30	100
HTG-410 / 5.0	5 mm ±0,40	100
HTG-410 / 6.0	6 mm ±0,40	100
HTG-410 / 7.0	7 mm ±0,50	50
HTG-410 / 8.0	8 mm ±0,50	50
HTG-410 / 10	10 mm ±0,50	50
HTG-410 / 12	12 mm ±0,60	50
HTG-410 / 14	14 mm ±0,60	50
HTG-410 / 16	16 mm ±0,60	50
HTG-410 / 18	18 mm ±0,80	50
HTG-410 / 20	20 mm ±0,80	25
HTG-410 / 25	25 mm ±0,80	25



*Çalışma Sıcaklığı -400C +4500C Isıl İşlem Görmüş Cam Elyaf Makaron. Halojen Free.

PVC MAKARON

Esnek ve düşük maliyetli olan yumuşak PVC makaron genellikle otomotiv, mekanik ve elektrik sektörlerinde tel ve kablo izolasyon alanında kullanılmaktadır. Sertlik Shore: 85 A

Sipariş Kodu	İç Çap (mm)	Et Kalınlığı (mm)	Renk	Rulo (m)
CTYM85 - 031	3.1 + 0.3	0.4 + (-0.15)	Siyah	400
CTYM85 - 041	4.1 + 0.3	0.5 + (-0.15)	Siyah	300
CTYM85 - 051	5.1 + 0.3	0.6 + (-0.15)	Siyah	200
CTYM85 - 061	6.1 + 0.3	0.6 + (-0.15)	Siyah	150
CTYM85 - 071	7.1 + 0.3	0.7 + (-0.15)	Siyah	150
CTYM85 - 081	8.1 + 0.3	0.7 + (-0.15)	Siyah	100
CTYM85 - 091	9.1 + 0.4	0.7 + (-0.15)	Siyah	100
CTYM85 - 101	10.1 + 0.4	0.7 + (-0.15)	Siyah	100
CTYM85 - 121	12.1 + 0.4	0.8 + (-0.15)	Siyah	50
CTYM85 - 141	14.1 + 0.5	1.0 + (-0.20)	Siyah	50
CTYM85 - 161	16.1 + 0.6	1.0 + (-0.20)	Siyah	50
CTYM85 - 181	18.1 + 0.6	1.0 + (-0.20)	Siyah	50
CTYM85 - 201	20.1 + 0.6	1.2 + (-0.20)	Siyah	50
CTYM85 - 221	22.1 + 0.6	1.2 + (-0.20)	Siyah	25
CTYM85 - 241	24.1 + 0.6	1.2 + (-0.20)	Siyah	25

Çalışma sıcaklığı : -20 °C, + 70 °C
 Yanıcılık : Kendiliğinden sönen
 Dielektrik dayanım : Min. 20 kV/mm (nach IEC 243)
 Özellikler : İzolasyon sınıfı YVDE 0530
 Standart renk : Siyah (Diğer renkler isteğe göre üretilir.)



Not: Renkli ürünlerde % 30 fiyat farkı uygulanır.

GENEL AMAÇLI PABUÇ SIKMA PENSESİ

CT-4 PLUS

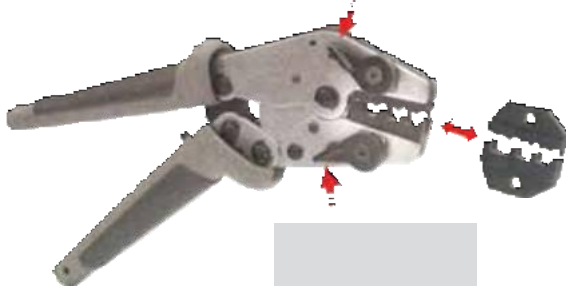

0,50 - 6,0 mm
Kablo Uçları



0,50 - 16 mm
İzoleli - İzolesiz YÜKSÜKLER



0,50 - 10 mm
Açık Tip Pabuçlar



25 - 35 - 50 mm
İzoleli - İzolesiz YÜKSÜKLER

PENSELER

TG-010

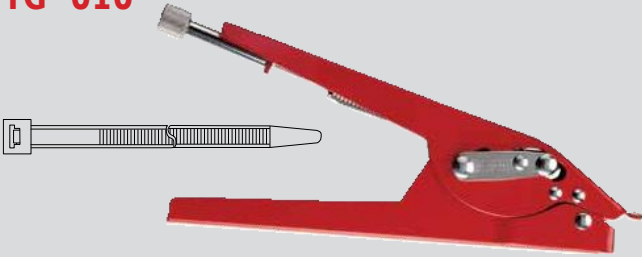

3.6 - 9.0 mm genişlikteki kablo bağlarını sıkar ve keser.

CTT



2.5 - 4.8 mm genişlikteki kablo bağlarını sıkar ve keser.

PENSELER

YYT-7



İzoleli Kablo Ucu Sıkma Pensesi (YÜKSÜKLÜ Tip)
0.25 - 6.00 mm² Sıkma Kuvvet Ayarlı

YYT-1



İzoleli Kablo Ucu Sıkma Pensesi
0.25 - 6.00 mm²

YAC-6



İzoleli ve İzolesiz Yüksek Sıkma Pensesi
6.00 - 16.00 mm², Sıkma Kuvvet Ayarlı

YAC-5



İzoleli ve İzolesiz Yüksek Sıkma Pensesi
0.50 - 6.00 mm², Sıkma Kuvvet Ayarlı

YAC-9



İzoleli ve İzolesiz Yüksek Sıkma Pensesi
0.08 - 6.00 mm², Altıgen Sıkma Şekli

YAC-8



İzoleli ve İzolesiz Yüksek Sıkma Pensesi
0.08 - 6.00 mm², Dörtgen Sıkma Şekli

YAC-35



İzoleli ve İzolesiz Yüksek Sıkma Pensesi
10.00 - 35.00 mm², Sıkma Kuvvet Ayarlı

YENİ

YAC-50



İzoleli ve İzolesiz Yüksek Sıkma Pensesi
25-35-50 mm², Sıkma Kuvvet Ayarlı

YENİ

PENSELER

YY-78 / 318



0.50 - 6.00 mm² Kabloları Soyma ve Kesme Pensesi
Set ve Yumuşak Kablolar İçin Soyma Kuvvet Ayarlı

JS-308



İzoleli ve İzolesiz Yüksek Sıkma Pensesi
0.50 - 16 mm²

YYT-11



0.50 - 6.00 mm² İzolesiz Terminal Sıkma Pensesi
Sıkma Kuvveti Ayarlı

JS-700 A

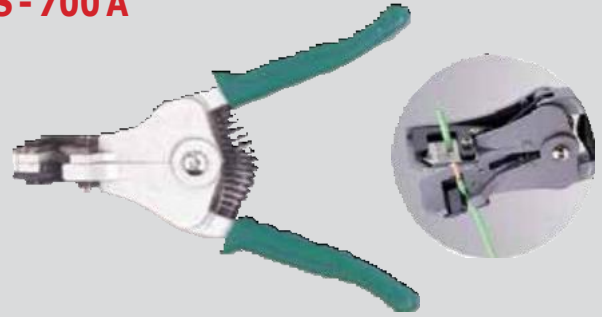

0.50 - 2.00 mm² Kabloları Soyma Pensesi

YAC-13



İzolesiz (Mikro / Küçük) Terminal Sıkma Pensesi
Sıkma Kuvvet Ayarlı

YAC-16



İzolesiz (Eğri / Bayrak Tip) Terminal Sıkma Pensesi
Sıkma Kuvvet Ayarlı

YYT-12



1,1 - 10 mm² İzolesiz Terminal
Sıkma Pensesi / Sıkma Kuvvet Ayarlı

HDF-0560



0.50-6.00 mm² izolesiz Terminal
Sıkma Pensesi Sıkma Kuvvet Ayarlı

4-28 H

4.00 - 28.00 mm² NYY Kablo Soyma

PENSELER
YYR-513

YYR-514

60.0 mm² Bakır ve ALÜMİNYUM
Kablo Kesme Makası

YYR-513

100.0 mm² Bakır ve ALÜMİNYUM
Kablo Kesme Makası

YYR-514

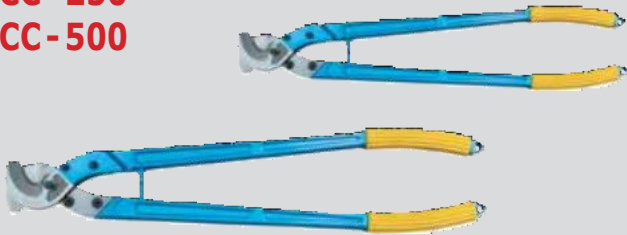
**CC-250
CC-500**

CC250

CC500

250.0 - 500.0 mm²
Bakır ve ALÜMİNYUM Kablo Kesme Makası

JSL-1367

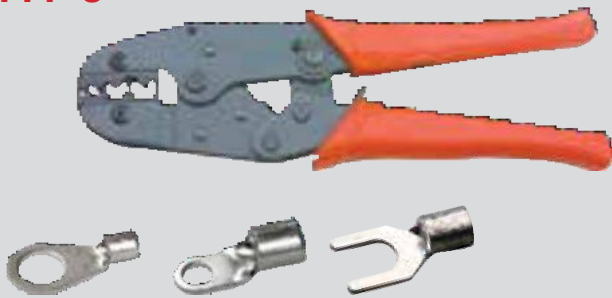

Bayrak Tipi İzoleli Terminaleri Sıkma Pensesi

YYT-8

1.50 - 10.0 mm²
İzolesiz Kablo Ucu Sıkma Pensesi

YYR-510

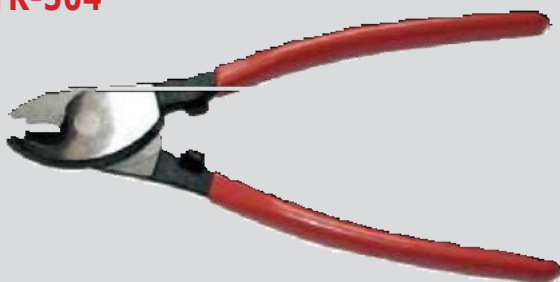
8.00-25.0mm²SKP / Kaynaklı Tip Sıkma Pensesi

YYR-504

1.00 - 38.00 mm²
Bakır ve ALÜMİNYUM Kablo Kesme Makası

DIN Normu SKP Sıkma Pensesi

MADE IN GERMANY

6.00 - 50.00 mm²SKP Sıkma Pensesi (Döner Çeneli)
10.00 - 120.00 mm²SKP Sıkma Pensesi (Döner Çeneli)

C-50

C-120

PORSELEN SİGORTALAR gL-gG

Sipariş Kodu	Cinsi	Amper (A)	K. Adedi
420500	8 x 31 gG Porselen Sigorta	0.5 A	-
420501		1 A	-
420502		2 A	-
420504		4 A	-
420506		6 A	-
420508		8 A	-
420510		10 A	-
420512		12 A	-
420516		16 A	-
420720		20 A	-



Sipariş Kodu	Cinsi	Amper (A)	K. Adedi
420000	10.3 x 38 gG Porselen Sigorta	0.5 A	-
420001		1 A	-
420002		2 A	-
420004		4 A	-
420006		6 A	-
420008		8 A	-
420010		10 A	-
420012		12 A	-
420016		16 A	-
420020		20 A	-
420025		25 A	-
420032		32 A	-



Sipariş Kodu	Cinsi	Amper (A)	K. Adedi
421001	14.3 x 51 gG Porselen Sigorta	1 A	-
421002		2 A	-
421004		4 A	-
421006		6 A	-
421008		8 A	-
421010		10 A	-
421012		12 A	-
421016		16 A	-
421020		20 A	-
421025		25 A	-
421032		32 A	-
421040		40 A	-
421050		50 A	-



PORSELEN SİGORTALAR gL-gG

Sipariş Kodu	Cinsi	Amper (A)	K. Adedi
422002	22.2x58gG Porselen Sigorta	2 A	-
422004		4 A	-
422006		6 A	-
422008		8 A	-
422010		10 A	-
422012		12 A	-
422016		16 A	-
422020		20 A	-
422025		25 A	-
422032		32 A	-
422040		40 A	-
422050		50 A	-
422063		63 A	-
422080		80 A	-
422000		100 A	-
422015		125 A	-



SİGORTA YUVALARI

Sipariş Kodu	Cinsi	K. Adedi
485001	PM-F 8 x 31 1P Sigorta Yuvası	-
485101	PM-F 10 x 38 1P Sigorta Yuvası	-
485104	PM-F 10 x 38 2P Sigorta Yuvası	-
485105	PM-F 10 x 38 3P (ÜÇLÜ) Sigorta Yuvası	-
485201	PM-X 14 x 51 1P Sigorta Yuvası	-
485204	PM-X 14 x 51 2P (İkili) Sigorta Yuvası	-
485205	PM-X 14 x 51 3P (ÜÇLÜ) Sigorta Yuvası	-
485207	PM-X 14 x 51 4P (DÖRTLÜ) Sigorta Yuvası	-
485301	PM-X 22 x 58 1P Sigorta Yuvası	-
485304	PM-X 22 x 58 2P (İkili) Sigorta Yuvası	-
485305	PM-X 22 x 58 3P (ÜÇLÜ) Sigorta Yuvası	-
485307	PM-X 22 x 58 4P (DÖRTLÜ) Sigorta Yuvası	-
480208	14 x 51 Yardımcı Kontaklı Tekli	-
480080	22 x 58 Yardımcı Kontaklı Tekli	-
485150	PM-F 10 x 38 1P 1000 VDC Sigorta Yuvası	-
485250	PM-X 14 x 51 1P 1000 VDC Sigorta Yuvası	-



NH SİGORTALAR (500 V)

Sipariş Kodu	Cinsi	Amper (A)	K. Adedi
381025	NH 000 gG	16 A	-
381030	NH 000 gG	25 A	-
381035	NH C00 gG	32 A	-
381040	NH C00 gG	35 A	-
381045	NH C00 gG	40 A	-
381050	NH C00 gG	50 A	-
381055	NH C00 gG	63 A	-
381060	NH C00 gG	80 A	-
381065	NH C00 gG	100 A	-
381070	NH 00 gG	125 A	-
381075	NH 00 gG	160 A	-



NH1 gG (500 V)

Sipariş Kodu	Cinsi	Amper (A)	K. Adedi
381230	NH C1 gG	50 A	-
381235	NH C1 gG	63 A	-
381240	NH C1 gG	80 A	-
381245	NH C1 gG	100 A	-
381250	NH C1 gG	125 A	-
381255	NH C1 gG	160 A	-
381260	NH 1 gG	200 A	-
381270	NH 1 gG	250 A	-
NH2 gG (500 V)			
381350	NH C2 gG	200 A	-
381360	NH 2 gG	315 A	-
381370	NH 2 gG	400 A	-



HIZLI SİĞORTALAR

Sipariş Kodu	Cinsi	Volt (V)	Amper (A)	K. Adedi
492001	10 x 38 Hızlı Sigorta	600 V	1 A	-
492002		600 V	2 A	-
492002		600 V	3 A	-
492003		600 V	4 A	-
492004		600 V	6 A	-
492005		600 V	8 A	-
492006		600 V	10 A	-
492007		600 V	12 A	-
492008		600 V	16 A	-
492009		600 V	20 A	-
492010		600 V	25 A	-
492011	600 V	32 A	-	
Sipariş Kodu	Cinsi	Volt (V)	Amper (A)	K. Adedi
491200	14 x 51 Hızlı Sigorta	660 V	1 A	-
491205		660 V	2 A	-
491210		660 V	3 A	-
492014		660 V	4 A	-
492015		660 V	6 A	-
492017		660 V	10 A	-
492018		660 V	12 A	-
492019		660 V	16 A	-
492020		660 V	20 A	-
492021		660 V	25 A	-
492022		660 V	32 A	-
492023		660 V	40 A	-
492024		660 V	50 A	-



Sipariş Kodu	Cinsi	Volt (V)	Amper (A)	K. Adedi
492033	22 x 58 Hızlı Sigorta	690 V	20 A	-
492034		690 V	25 A	-
492035		690 V	32 A	-
492036		690 V	40 A	-
492037		690 V	50 A	-
492038		690 V	63 A	-
492039		690 V	80 A	-
492040		690 V	100 A	-





ÖLÇÜ ALETİ SİGORTASI

Sipariş Kodu	Cinsi	K. Adedi
416005	10 x 35 440 mA 1000V Ac/Dc Porselen Sigorta	10
416010	10 x 35 11A 1000V Ac/Dc Porselen Sigorta	10



NÖTR

Sipariş Kodu	Cinsi	K. Adedi
431000	10 x 38 mm Nötr	-
432000	14 x 51 mm Nötr	-
433000	22 x 58 mm Nötr	-



NORMAL BUŞON

Sipariş Kodu	Cinsi	K. Adedi
101002-25	DI SİZE; 2-4-6-10-16-20-25 A, 500 V, 50 kA, E16	-
101102-25	DII SİZE; 2-4-6-10-16-20-25 A, 500 V, 50 kA, E27	-
101135-63	DIII SİZE; 35-50-63 A, 500 V, 50 kA, E33	-



NEOZED BUŞON

Sipariş Kodu	Cinsi	K. Adedi
201102-16	DO 1 SİZE; 2-4-6-10-16 A, 400 V, 50 kA, E14	-
201120-63	DO 2 SİZE; 20-25-35-50-63 A, 400 V, 50 kA, E18	-



NH ALTLIK

Sipariş Kodu	Cinsi	Amper (A)	K. Adedi
350250	NH 1 Altık CR (Porselen)	250 A	-
354100	NH 00 Altık CR (Polyester)	160 A	-
354400	NH 2 Altık CR (Polyester)	400 A	-
353102	NH 00 3'LÜ Altık CR (Porselen) Kapaksız	160 A	-
334717	NH 00 3'LÜ Altık CR (Porselen) Kapaklı	160 A	-
340001	NH 00-4 Ellik	-	-



10 x 38 1000 VDC SOLAR SİGORTA BUŞONU

Sipariş Kodu	Cinsi	Amper (A)	K. Adedi
491601-635	10 x 38, 1000 VDC, Solar Sigorta Buşonu	1-20 A	-
491901-945	10 x 38, 600 VDC, Solar Sigorta Buşonu	1-32 A	-
491650	14 x 51, 1000 VDC, Solar Sigorta Buşonu	25 A	-
491655	14 x 51, 1000 VDC, Solar Sigorta Buşonu	32 A	-
485150	Sigorta Yuvası PM-F 10 x 38 1P 1000 VDC	-	-
485250	Sigorta Yuvası PM-X 14 x 51 1P 1000 VDC	-	-

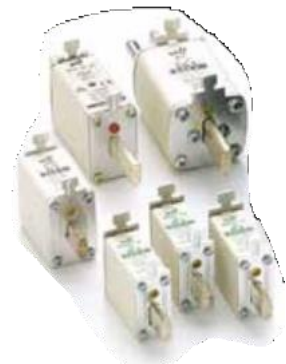

Onka®

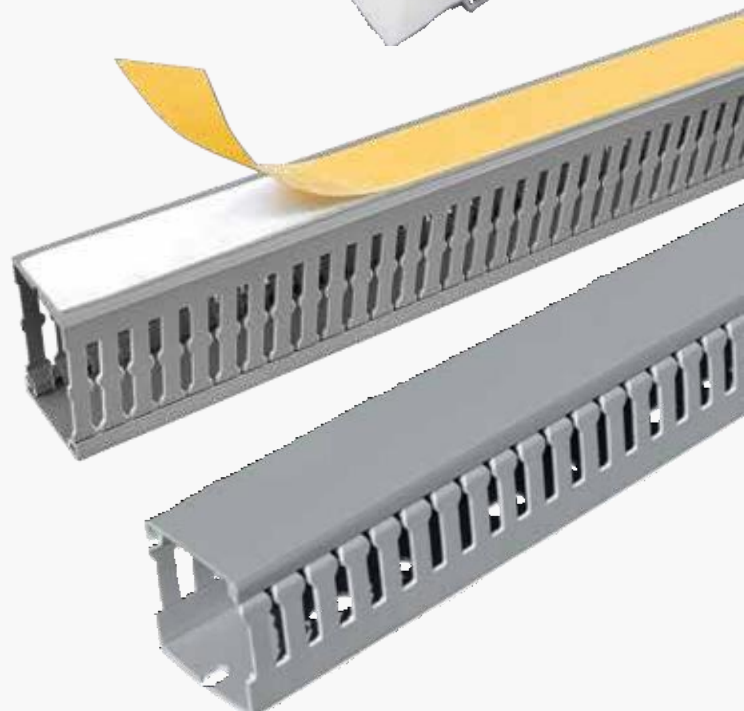
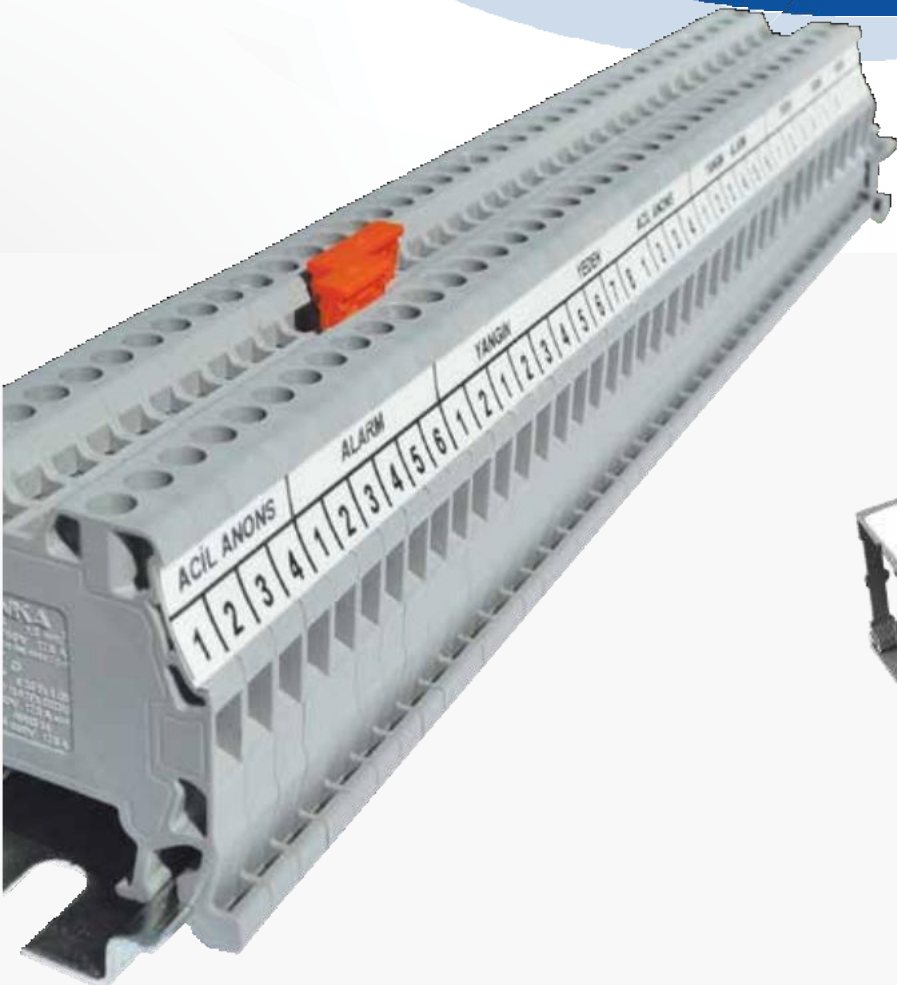



MRK SERİSİ VIDA BASKILI RAY KLEMENSLER (HER İKİ TARAFI KAPALI SİSTEM)



Sipariş Kodu	Cinsi	Kablo Kesiti	Voltaj (V)	Amper (A)	K. Adedi
1002	MRK - 1,5 mm ²	1,5 mm ²	750 V	17.5 A	100
1012	MRK - 2,5 mm ²	2,5 mm ²	750 V	24 A	100
1022	MRK - 4 mm ²	4 mm ²	750 V	32 A	100
1032	MRK - 6 mm ²	6 mm ²	750 V	41 A	100
1042	MRK - 10 mm ²	10 mm ²	750 V	57A	100
1052	MRK - 16 mm ²	16 mm ²	750 V	76 A	50
1062	MRK - 35 mm ²	35 mm ²	750 V	125 A	30
1072	MRK - 50 mm ²	50 mm ²	750 V	150 A	20
1082	MRK - 70 mm ²	70 mm ²	750 V	192 A	20
1092	MRK - 95 mm ²	95 mm ²	1000 V	232 A	10
1102	MRK - 120 mm ²	120 mm ²	1000 V	269 A	10

MRK SLİM SERİSİ VIDA BASKILI RAY KLEMENSLER (HER İKİ TARAFI KAPALI SİSTEM)



Sipariş Kodu	Cinsi	Kablo Kesiti	Voltaj (V)	Amper (A)	K. Ad.
0902	MRK - 2,5 mm ² SLİM SERİ	2,5 mm ²	750 V	24 A	100
0912	MRK - 4 mm ² SLİM SERİ	4 mm ²	750 V	32 A	100
1132	MRK - 16 mm ² SLİM SERİ	16 mm ²	750 V	76 A	50
1142	MRK - 35 mm ² SLİM SERİ	35 mm ²	750 V	125 A	30

TAKILABİLEN RAY ÇEŞİTLERİ

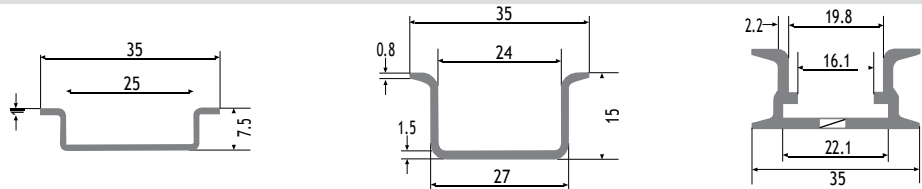

MRK RAY KLEMENS RENK KODLARI

GRİ	KREM	SİYAH	MAVİ	KAHVERENGİ	KIRMIZI	SARI	YEŞİL
02	03	04	05	06	07	08	09

MRK SERİSİ ÇİFT KATLI RAY KLEMENSLER



Sipariş Kodu	Cinsi	Kablo Kesiti	Voltaj (V)	Amper (A)	K. Adedi	t
1612	MRK -Ç 2,5 mm ²	2,5 mm ²	500 V	24 A	50	
1622	MRK -Ç 2,5 mm ² Köprülü	2,5 mm ²	500 V	24 A	50	
1652	MRK -Ç 4 mm ²	4 mm ²	500 V	32 A	50	
1662	MRK -Ç 4 mm ² Köprülü	4 mm ²	500 V	32 A	50	

MRK-S SERİSİ SİGORTALI RAY KLEMENSLER (BARALIVE LED'Lİ)



Sipariş Kodu	Cinsi	Kablo Kesiti	Voltaaj (V)	Amper (A)	K. Adedi
1322	MRK-S 6 mm ²	6 mm ²	Boş	6.3 A	100
1332	MRK-S 6 mm ²	6 mm ²	Baralı	6.3 A	100
1342	MRK-S 6 mm ²	6 mm ²	12 VAC/DC LED	6.3 A	100
1352	MRK-S 6 mm ²	6 mm ²	24 V DC LED	6.3 A	100
1372	MRK-S 6 mm ²	6 mm ²	48 V DC LED	6.3 A	100
1392	MRK-S 6 mm ²	6 mm ²	110 V DC LED	6.3 A	100
1402	MRK-S 6 mm ²	6 mm ²	220 V AC LED	6.3 A	100

MRK SERİSİ TOPRAKLAMA KLEMENSLER

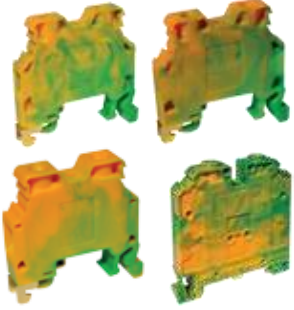

Sipariş Kodu	Cinsi	K. Adedi
1291	MTK 2,5 mm ²	100
1293	MTK 4 mm ²	100
1294	MTK 10 mm ²	100
1295	MTK 16 mm ²	50
1296	MTK 35 mm ²	30

MRK TEST KLEMENS 6'LİK (Bıçaklı Kapalı Sistem)



Sipariş Kodu	Cinsi	K. Adedi
1317	Bıçaklı Sistem Çift Kovanlı	100

MRK TEST KLEMENS 10'LUK



Sipariş Kodu	Cinsi	K. Adedi
1310	Kovansız	75
1311	Tek Kovanlı	75
1312	Çift Kovanlı	75
1306	Tek Test Proplu	75
1308	Çift Test Proplu	75

MRK TEST KLEMENS 10'LUK TEST KOVANI VE ÜST KÖPRÜLÜ



Sipariş Kodu	Cinsi	K. Adedi
1305	4'lü Set Çift Kovanlı 4'lü Set KöprülÜ Test Kovanlı	100



MRK TEST KLEMENSİ ÜST KÖPRÜ VE TEST KOVANI



Sipariş Kodu	Cinsi	K. Adedi
1303	2'li Üst Köprü	100
1318	4'lü Üst Köprü	50
1302	8'li Üst Köprü	-
1319	Test Probu	50
1304	Üst Köprü Test Kovanı	50

MRK SERİSİ RAY KLEMENS ÜST KÖPRÜ (Geçmeli)



Sipariş Kodu	Cinsi	K. Adedi
1920	1.5 x 2	100
1921	1.5 x 3	100
1922	1.5 x 4	100
1923	1.5 x 10	30
1924	1.5 x 20	20
1925	2.5 x 2	100
1926	2.5 x 3	100
1927	2.5 x 4	75
1928	2.5 x 10	30
1929	2.5 x 20	20
1930	4 x 2	100
1931	4 x 3	100
1932	4 x 4	50
1933	4 x 10	30
1934	4 x 20	20
1935	6 x 2	100
1936	6 x 3	50
1937	6 x 4	50
1938	6 x 10	15
1939	6 x 20	10
1940	10 x 2	100
1941	10 x 3	50
1942	10 x 4	50
1943	10 x 10	15
1944	10 x 20	10

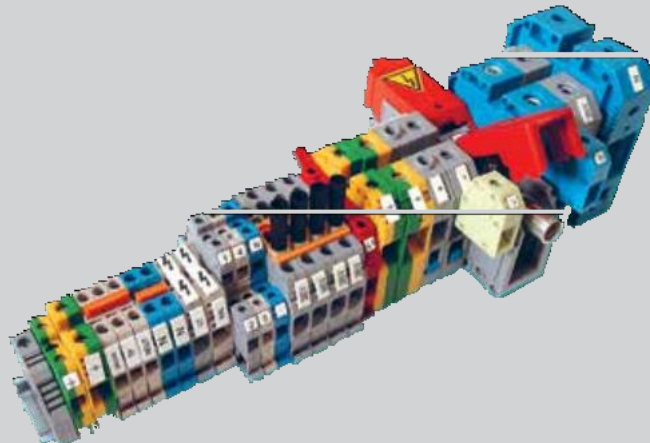

OPK SERİSİ YAY BASKILI RAY KLEMENSLER (PUSH-IN SİSTEM)

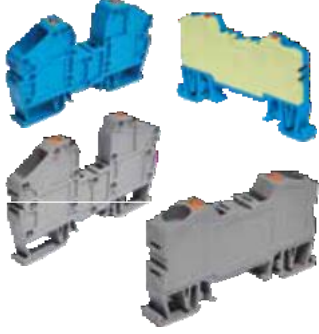

Sipariş Kodu	Cinsi	Kablo Kesiti	Voltaj (V)	Amper (A)	K. Adedi
1502	OPK - 2,5 mm ²	2,5 mm ²	750 V	24 A	100
1512	OPK - 4 mm ²	4 mm ²	750 V	32 A	100
1522	OPK - 6 mm ²	6 mm ²	750 V	41 A	100
1532	OPK - 10 mm ²	10 mm ²	750 V	57A	100
1542	OPK - 16 mm ² Çift Yay Baskılı Sistem	16 mm ²	750 V	76 A	30
1552	OPK - 35 mm ² Çift Yay Baskılı Sistem	35 mm ²	750 V	125 A	20

OPK SERİSİ YAY BASKILI İKİ KATLI KLEMENSLER



Sipariş Kodu	Cinsi	K. Kesiti	Voltaj (V)	Amper (A)	K. Adedi
1782	OPK - Ç 2,5 mm ²	2,5 mm ²	750 V	24 A	50
2572	OPK - Ç 2,5 mm ² İçten KöprüLÜ	2,5 mm ²	750 V	24 A	50
2582	OPK - Ç 2,5 mm ² Diyotlu YöNLÜ	2,5 mm ²	750 V	24 A	50
1792	OPK - Ç 4 mm ²	4 mm ²	750 V	32 A	50
2592	OPK - Ç 4 mm ² İçten KöprüLÜ	4 mm ²	750 V	32 A	50
2602	OPK - Ç 4 mm ² Diyotlu YöNLÜ	4 mm ²	750 V	32 A	50

OPK SERİSİ YAY BASKILI ÜÇ KATLI KLEMENSLER



Sipariş Kodu	Cinsi	K. Kesiti	Voltaj (V)	Amper (A)	K. Adedi
1852	OPK - 3 2,5 mm ²	2,5 mm ²	750 V	24 A	50
1862	OPK - 3 2,5 mm ² İçten KöprüLÜ	2,5 mm ²	750 V	24 A	50
1872	OPK - 3 2,5 mm ² Topraklı	2,5 mm ²	750 V	24 A	50
1882	OPK - 3 4 mm ²	4 mm ²	750 V	32 A	50
1892	OPK - 3 4 mm ² KöprüLÜ	4 mm ²	750 V	32 A	50
1902	OPK - 3 4 mm ² Topraklı	4 mm ²	750 V	32 A	50

TAKILABİLEN RAY ÇEŞİTLERİ

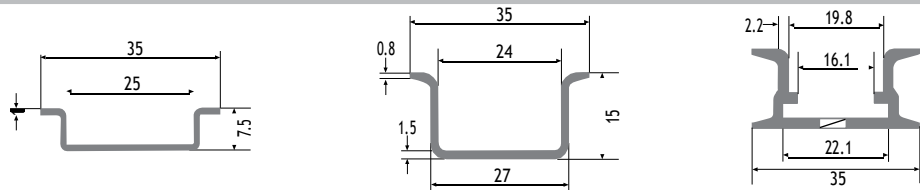

OPK RAY KLEMENS RENK KODLARI

GRİ

02

KREM

03

SİYAH

04

MAVİ

05

KAHVERENGİ

06

KIRMIZI

07

SARI

08

YEŞİL

09

OPK SERİSİ YAY BASKILI SİGORTALI RAY KLEMENS

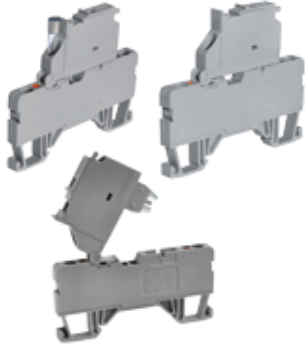

Sipariş Kodu	Cinsi	K. Kesiti	Voltaj (V)	Amper (A)	K. Adedi
2482	OPK-S 2.5 mm ²	2.5 mm ²	Boş	6.3 A	50
2492	OPK-S 2.5 mm ²	2.5 mm ²	Baralı	6.3 A	50
2502	OPK-S 2.5 mm ²	2.5 mm ²	12 VAC/DCLED	6.3 A	50
2512	OPK-S 2.5 mm ²	2.5 mm ²	24 V DC LED	6.3 A	50
2532	OPK-S 2.5 mm ²	2.5 mm ²	48 V DC LED	6.3 A	50
2552	OPK-S 2.5 mm ²	2.5 mm ²	110 V DC LED	6.3 A	50
2562	OPK-S 2.5 mm ²	2.5 mm ²	220 AC LED	6.3 A	50

OPK SERİSİ YAY BASKILI TOPRAKLAMA KLEMENSLERİ

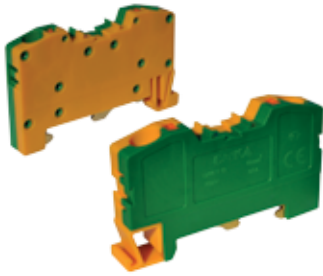

Sipariş Kodu	Cinsi	K. Kesiti	Voltaj (V)	Amper (A)	K. Adedi
1199	OPK - T 4 mm ²	4 mm ²	750 V	32 A	100
1200	OPK - T 10 mm ²	10 mm ²	750 V	57 A	100

OPK SERİSİ RAY KLEMENS ÜST KÖPRÜ (Geçmeli)

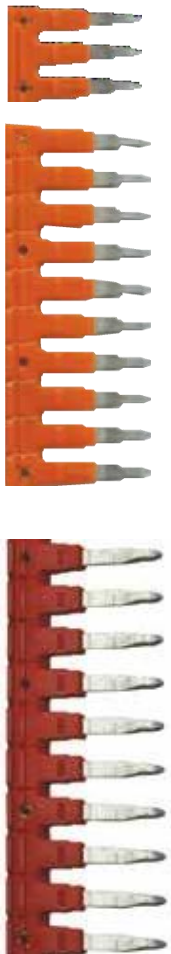

Sipariş Kodu	Cinsi	K. Adedi
1925	2.5 x 2	100
1926	2.5 x 3	100
1927	2.5 x 4	75
1928	2.5 x 10	30
1929	2.5 x 20	20
1930	4 x 2	100
1931	4 x 3	100
1932	4 x 4	50
1933	4 x 10	30
1934	4 x 20	20
1945	6 x 2	100
1946	6 x 3	50
1947	6 x 4	50
1948	6 x 10	15
1949	6 x 20	10
1950	10 x 2	100
1951	10 x 3	50
1952	10 x 4	50
1953	10 x 10	15
1954	10 x 20	10
1955	16 x 2	10
1956	16 x 3	10
1957	16 x 4	10
1958	16 x 10	10
1959	35 x 2	10
1960	35 x 3	10
1961	35 x 4	10
1962	35 x 10	10



DEKAFİKSLER (MRK ve OPK SERİSİ)

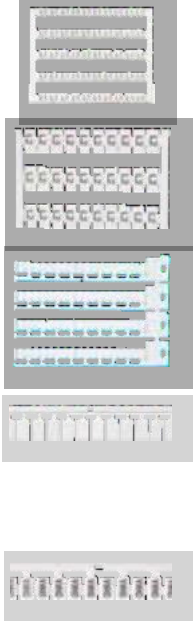

Sipariş Kodu	Cinsi	K. Adedi
9540	OD5-5 Baskısız	500
9541	OD5-5B Baskılı	500
9770	OD10-6 Baskısız	300
9771	OD10-6B Baskılı	300
5443	OD10-5P Baskısız, Birleşik Kopan	880
5444	OD10-5P Baskılı, Birleşik Kopan	880
4440	OD10-6P Baskısız Birleşik Kopan	720
4441	OD10-6P Baskılı Birleşik Kopan	720
4442	OD10-6P Baskısız Tek Tek Kopan	720
4443	OD10-6P Baskılı Tek Tek Kopan	720
4390	OD10-6P Baskısız, Birleşik Kopan	640
4391	OD10-6P Baskılı, Birleşik Kopan	640
2630	OD10-8P Baskısız, Birleşik Kopan	560
2631	OD10-8P Baskılı, Birleşik Kopan	560

MRK VE OPK SERİSİ DURDURUCULAR

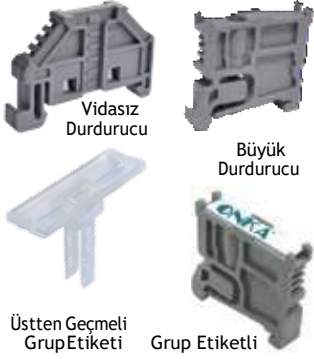

Sipariş Kodu	Cinsi	K. Adedi
1222	Küçük Durdurucu	100
1202	Vidasız Durdurucu	100
1212	Büyük Durdurucu	100
1232	Grup Etiketli	100
1482	Üstten Geçmeli Grup Etiketli	100

RAY MONTE KORUMA TUTUCU AYAĞI VE KAPAĞI



Sipariş Kodu	Cinsi	K. Adedi
1205	35'lik Tutucu Ayağı	100
1206	Koruma Kapağı	mt.

RAY KLEMENS İŞARETLERİ VE ETİKET YUVASI



Sipariş Kodu	Cinsi	K. Adedi
1287	Klemens Şimşek İşaretlemesi	1.000
1289	Ray Klemens 11-12 mm Etiket Yuvası	1.000
7301	11 mm x 2 x 20 m Duple Şerit Etiket	40 mt.



MPK SERİSİ MİNİ YAY BASKILI KLEMENSLER (PUSH-IN KAPALI SİSTEM)



Sipariş Kodu	Cinsi	K. Kesiti	Voltaj (V)	K. Adedi	⌘
1422	MPK-2,5mm ² 24A	2,5 mm ²	750 V	100	

MPK SERİSİ MİNİ YAY BASKILI TOPRAKLI KLEMENS (PUSH-IN KAPALI SİSTEM)



Sipariş Kodu	Cinsi	K. Kesiti	Voltaj (V)	K. Adedi	⌘
1470	MPK-2,5mm ² 24A	2,5 mm ²	750 V	100	

MP SERİSİ MİNİ YAY BASKILI KLEMENSLER (PUSH-IN KAPALI SİSTEM)

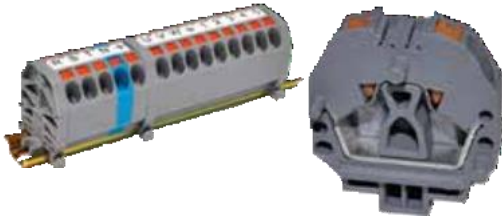

Sipariş Kodu	Cinsi	K. Kesiti	Voltaj (V)	K. Adedi	⌘
1461	MP - 2,5 mm ² 24 A	2,5 mm ²	750 V	100	

DURDURUCU VE SONLANDIRICI



Sip. Kodu	Cinsi	K. Ad.	⌘
1442	Durdurucu ve Sonlandırıcı Raya takılabilir ve zemine vidalanabilir.	100	

DURDURUCU VE SONLANDIRICI



Sip. Kodu	Cinsi	K. Ad.	⌘
1452	Durdurucu ve Sonlandırıcı Zemine geçmeli.	100	

DEKAFİKSLER



Sipariş Kodu	Cinsi	K. Adedi	⌘
9540	OD5-5 Baskısız	500	
9541	OD5-5B Baskılı	500	

TAKILABİLEN RAY ÇEŞİDİ

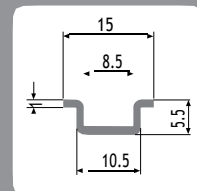

MPK RAY KLEMENS RENK KODLARI

GRI	KREM	SIYAH	MAVİ	KAHVERENGİ	KIRMIZI	SARI	YEŞİL
02	03	04	05	06	07	08	09

PANO İÇİ DELİKLİ KABLO KANALLARI

GRİ (DELİKLİ)

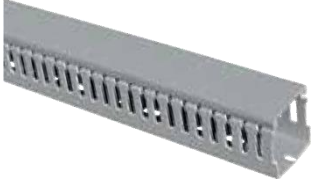

Sipariş Kodu	EBAT (w x h) (Genişlik x Derinlik)	KUTU / M.	HALOJEN FREE KODU
7180	25 x 30 mm	84	7310
7181	25 x 40 mm	84	7311
7182	25 x 60 mm	48	7312
7183	40 x 40 mm	60	7313
7184	40 x 60 mm	36	7314
7186	40 x 80 mm	40	7315
7177	60 x 40 mm	40	7316
7185	60 x 60 mm	24	7317
7188	60 x 80 mm	24	7318
7187	80 x 60 mm	24	7319
7178	80 x 80 mm	24	7320
7179	100 X 60 mm	24	7321

SIVA ÜSTÜ KABLO KANALI (BEYAZ DÜZ)



Sipariş Kodu	EBAT (w x h) (Genişlik x Derinlik)	KUTU / M.	HALOJEN FREE KODU
7200	16 x 16 mm	256	7350
7201	25 x 16 mm	160	7351
7202	25 x 25 mm	100	7352
7203	40 x 25 mm	60	7353
7204	40 x 40 mm	48	7354

KAPAKLAR



Sipariş Kodu	GENİŞLİK	KUTU / M.	HALOJEN FREE KODU
7290	25 mm	140	7295
7291	40 mm	80	7296
7292	60 mm	50	7297
7293	80 mm	50	7298
7294	100 mm	40	7299

DAHİLİ TİP A.G. MESNET İZOLATÖRLER (Cam Elyaf)

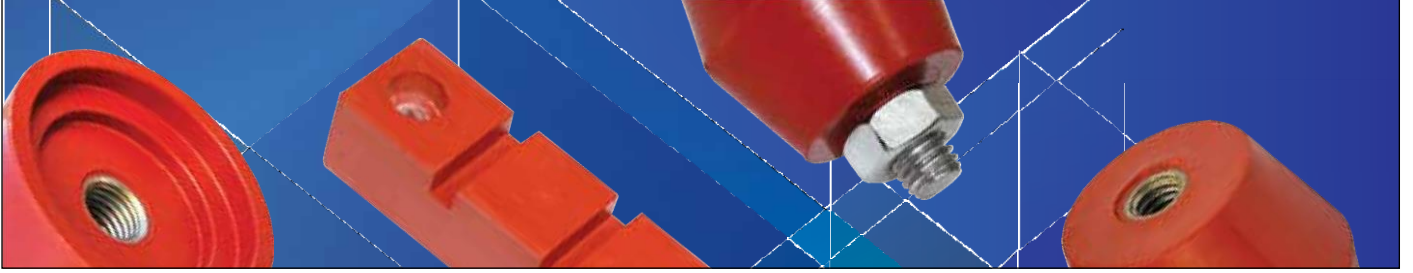

Çift Taraf Saplmalı Mesnet İzolatörleri

Sipariş Kodu	TİP	ÖLÇÜLER					Voltaj (~kV)	Kutu Adedi	t
		a	b1	b2	e	h			
CT-CE1001	1N0-S	5	13	13	22	24	0,6	500	
CT-CE1002	1N1-S	6	12	14	27	28	0,6	300	
CT-CE1003	1NMS-1	8	16	19	40	40	1	100	
CT-CE1004	1NMS-2	10	14,5	19	40	40	1	100	

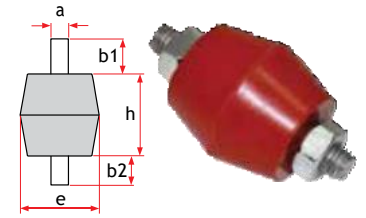

Saplama & Kör Somunlu Mesnet İzolatörleri

Sipariş Kodu	TİP	ÖLÇÜLER					Voltaj (~kV)	Kutu Adedi	t
		a	b1	b2	e	h			
CT-CE1005	1N0-K	5	13	12	22	24	0,6	500	
CT-CE1006	1N1-K	6	14	15	27	28	0,6	300	
CT-CE1007	1NMK-3	8	17	15	40	40	1	100	
CT-CE1008	1NMK-2	10	15	15	40	40	1	100	

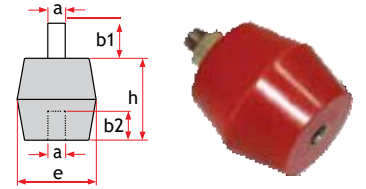

Çift Taraf Kör Somunlu Mesnet İzolatörleri

Sipariş Kodu	TİP	ÖLÇÜLER					Voltaj (~kV)	Kutu Adedi	t
		a	b1	b2	e	h			
CT-CE1009	1N0-KK	5	9	9	22	24	0,6	500	
CT-CE1010	1N1-KK	6	12	12	27	28	0,6	300	
CT-CE1011	1NMK-4	8	15	15	40	40	1	100	
CT-CE1012	1NMK-1	10	15	15	40	40	1	100	

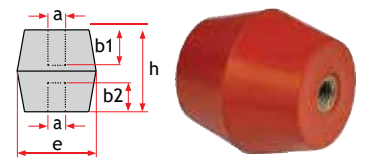

CT-CE1NMD-1	M16 Kör Somunlu Cam Elyaf Polyester Mesnet İzolatörleri	3	18
-------------	---	---	----

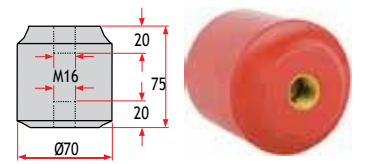

CT-CE1NMA-2	M12-16 Kör Somunlu Konik, Cam Elyaf Polyester Mesnet İzolatörleri	3	18
-------------	---	---	----

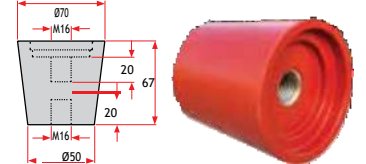

CT-CE1NMC-3	M16 Kör Somunlu Cam Elyaf Polyester Mesnet İzolatörleri	3	18
-------------	---	---	----

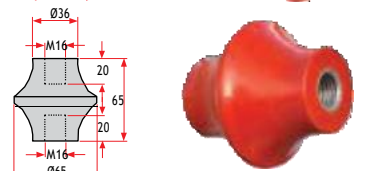

CT-CE1N500/8	M8 - M10 - M12 Kör Somunlu Cam Elyaf Polyester Mesnet İzolatörleri	3	32
CT-CE1N500/10		3	32
CT-CE1N500/12		3	32

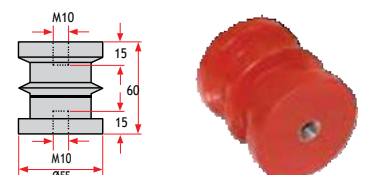

CAM ELYAF POLYESTER TARAK İZOLATÖRLERİ

Sipariş Kodu	Tip	Açıklama	Voltaj (~kV)	Kutu Adedi
CT-CE-T1002	3x1F/5-10mm L=193mm	Cam Elyaf Polyester Mesnet Tarak İzolatörleri	5	40
CT-CE--T1007	3x2F/10mm L=285mm	Cam Elyaf Polyester Mesnet Tarak İzolatörleri	5	50
CT-CE--T1008	3x2F/5mm L=285mm	Cam Elyaf Polyester Mesnet Tarak İzolatörleri	5	50
CT-CE--T1003	3 x 1FK/5 mm Cu L = 134 mm	Cam Elyaf Polyester Mesnet Tarak İzolatörleri	5	50
CT-CE--T1004	3 x 1F+N/5 mm L = 134 mm	Cam Elyaf Polyester Mesnet Tarak İzolatörleri	5	50
CT-CE--T1001	1x4F/10mm L=134mm	Cam Elyaf Polyester Mesnet Tarak İzolatörleri	5	50
CT-CE--T1005	3x1F+N/5-10mm L=230mm	Cam Elyaf Polyester Mesnet Tarak İzolatörleri	5	32
CT-CE--T1006	3x1FY+N L=150mm	Cam Elyaf Polyester Mesnet Tarak İzolatörleri	5	26
CT-CE--T1009	3x2F+N/5-10mm L=303mm	Cam Elyaf Polyester Mesnet Tarak İzolatörleri	5	50
CT-CE--T1010	3x3F/5-10mm L=340mm	Cam Elyaf Polyester Mesnet Tarak İzolatörleri	5	50
CT-CE--T1012	3x1F/5-10mm L=193mm	Cam Elyaf Polyester Mesnet Tarak İzolatörleri	5	40
CT-CE--T1013	3x1F+N/5-10mm L=269mm	Cam Elyaf Polyester Mesnet Tarak İzolatörleri	5	50
CT-CE--GK1	M6, 100 A L=100mm	Cam Elyaf Polyester Geçiş İzolatörü	-	1
CT-CE--GK2	M12 200 A	Cam Elyaf Polyester Geçiş İzolatörü	-	1

t



DAHİLİ TİP A.G. MESNET İZOLATÖR (Yanmaz Plastik)

Çift Taraf Saplmalı Mesnet İzolatörleri

Sipariş Kodu	TİP	ÖLÇÜLER					Voltaj (~kV)	Kutu Adedi
		a	b1	b2	e	h		
CT-PL1001	1N0-S	5	12	12	18	25,5	0,6	500
CT-PL1002	1N1-S	6	16	16	21	29,5	0,6	300
CT-PL1003	1NMS-1	8	15	15	31,5	40	1	100
CT-PL1004	1NMS-2	10	15	15	31,5	40	1	100
CT-PL1013	1NMS-3	8	18	18	4,3	50	1	100
CT-PL1014	1NMS-4	10	18	18	43,3	50	1	100

t

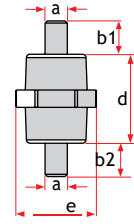

Saplama & Kör Somunlu Mesnet İzolatörleri

Sipariş Kodu	TİP	ÖLÇÜLER					Voltaj (~kV)	Kutu Adedi
		a	b1	b2	e	h		
CT-PL1005	1N0-K	5	12	9	18	25,5	0,6	500
CT-PL1006	1N1-K	6	16	12	21	29,5	0,6	300
CT-PL1007	1NMK-3	8	15,5	15	31,5	40	1	100
CT-PL1008	1NMK-2	10	15	15	31,5	40	1	100
CT-PL1015	1NMK-5	8	18	15	43,3	50	1	100
CT-PL1016	1NMK-6	10	18	15	43,3	50	1	100

t

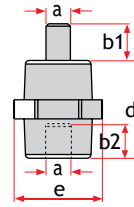

Çift Taraf Kör Somunlu Mesnet İzolatörleri

Sipariş Kodu	TİP	ÖLÇÜLER					Voltaj (~kV)	Kutu Adedi
		a	b1	b2	e	h		
CT-PL1009	1N0-KK M5	5	9	9	18	25,5	0,6	500
CT-PL1010	1N1-KK M6	6	12	12	21	29,5	0,6	300
CT-PL1011	1NMK-4 M8	8	15	15	31,5	40	1	100
CT-PL1012	1NMK-1 M10	10	15	15	31,5	40	1	100
CT-PL1017	1NMK-7 M8	8	15	15	43,3	50	1	100
CT-PL1018	1NMK-8 M10	10	15	15	43,3	50	1	100

t

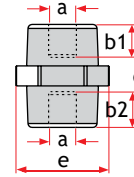

Sipariş Kodu	Tip	Açıklama	Kutu Adedi
CT-PL-S1001	3x1F/5-10 mm	Yanmaz Plastik (V0) Tarak İzolatörleri	30
CT-PL-S1003	3x1F+N /5-10 mm	Yanmaz Plastik (V0) Tarak İzolatörleri	30
CT-PL-S1002	3x2F/10 mm	Yanmaz Plastik (V0) Tarak İzolatörleri	50
CT-PL-S1012	1x2F - 1x3F/5-10 mm	Yanmaz Plastik (V0) Tarak İzolatörleri	100
CT-PL-S1009	1x4F/10 mm	Yanmaz Plastik (V0) Tarak İzolatörleri	80
CT-PL-S1011	1x3F/5 mm	Profil Bağlantılı Plastik (V0) Tarak İzolatörleri	100
CT-PL-S1005	1x4F/5 mm	Profil Bağlantılı Plastik (V0) Tarak İzolatörleri	100
CT-PL-S1007	1x2F/10 mm	Profil Bağlantılı Plastik (V0) Tarak İzolatörleri	100
CT-PL-S1008	1x3F/10 mm	Profil Bağlantılı Plastik (V0) Tarak İzolatörleri	100
CT-PL-S1006	1x4F/10 mm	Profil Bağlantılı Plastik (V0) Tarak İzolatörleri	100
CT-PL-S1010	1x3F/10 mm	Profil Bağlantılı Plastik (V0) Tarak İzolatörleri	100
CT-PL-S1013	20x3/20x4/30x5/30x10	Geçiş İzolatörü	100
CT-PL-S1014	25x5/20x10/40x10/50x10	Geçiş İzolatörü	100

t





PANO ETİKET AYAĞI (Polyamid 6 V0)

7.60 ₺



UYGULAMA YERİ



CAM ELYAF PLAKA

Bu ürünler elyazırma yöntemi ile imalat edilen plaka şeklinde ürünlerdir. pano içinde bakır baraları taşımak ve mesnetlemek amacı ile kullanılır. Ürünler BMC tipi dediğimiz mesnet izolatörlerine göre mekanik dayanımı fazla olan ürünlerdir. Uygulama şekilleri yandakigibidir.



BARA TUTUCUSERFİLLER

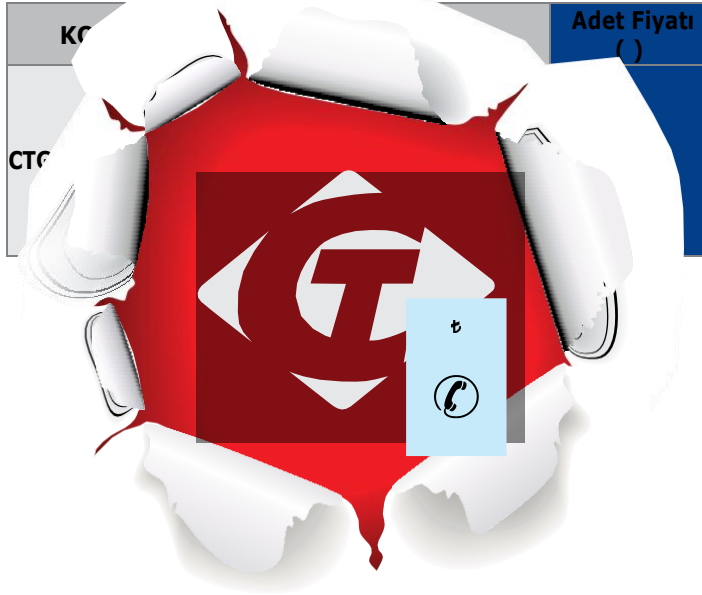

PANO TOPRAKLAMA KLEMENSLERİ VE DAĞITICI ÜNİTELER

PANOTOPRAKLAMA KLEMENSLERİ (6.5x9 mm KESİT) 80 AMPER

Sipariş Kodu	Cinsi	A	B	L	Kutu Adedi	⌚
2001	2/3=5Delikli PanoTop. Klemensi	6,5	9	42	50	
2002	2/5=7Delikli PanoTop. Klemensi	6,5	9	54	50	
2003	2/8=10Delikli PanoTop. Klemensi	6,5	9	73	50	
2004	2/10=12Delikli PanoTop. Klemensi	6,5	9	86	50	
2005	2/13=15Delikli PanoTop. Klemensi	6,5	9	105	50	
2006	2/20=22Delikli PanoTop. Klemensi	6,5	9	148	50	
2007	2/40=42Delikli PanoTop. Klemensi	6,5	9	285	50	
2008	2/60=62Delikli PanoTop. Klemensi	6,5	9	410	50	
2009	2/80=82Delikli PanoTop. Klemensi	6,5	9	535	50	
1999	1 mt: 159 Delik	-	-	-	50	

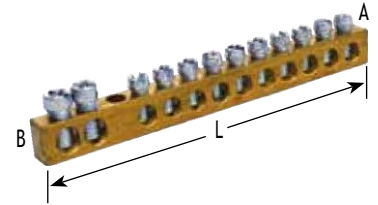

**Çok Telli Kablo kesiti max. 10 mm²
Tek Damarlı Kablo kesiti max. 16 mm²**

PANOTOPRAKLAMA KLEMENSLERİ (7x12 mm KESİT) 100 AMPER

Sipariş Kodu	Cinsi	A	B	L	Kutu Adedi	⌚
2021	2/5=7Delikli PanoTop. Klemensi	7	12	69	50	
2022	2/8=10Delikli PanoTop. Klemensi	7	12	93	50	
2023	2/10=12Delikli PanoTop. Klemensi	7	12	119	50	
2024	2/13=15Delikli PanoTop. Klemensi	7	12	133	50	
2025	2/20=22Delikli PanoTop. Klemensi	7	12	188	50	
2029	1 mt: 126 Delik	-	-	-	50	

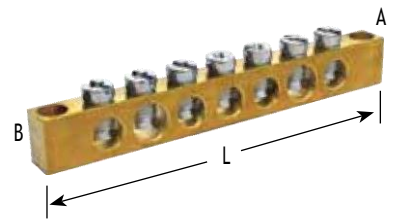

Kablo kesiti max. 25 mm

PANO TOPRAKLAMA KLEMENSLERİ (10 x 15 mm KESİT) 150 AMPER

Sipariş Kodu	Cinsi	A	B	L	Kutu Adedi	⌚
2041	2/5=7Delikli PanoTop. Klemensi	10	15	124	50	
2042	2/8=10Delikli PanoTop. Klemensi	10	15	149	50	
2043	2/10=12Delikli PanoTop. Klemensi	10	15	173	50	
2044	2/13=15Delikli PanoTop. Klemensi	10	15	211	50	
2045	2/20=22Delikli PanoTop. Klemensi	10	15	308	50	
2028	1 mt: 79 Delik	-	-	-	50	

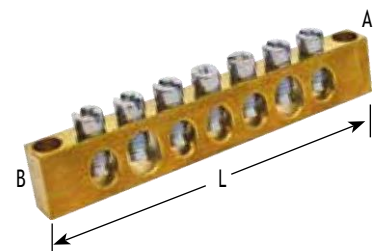

Kablo kesiti max. 50 mm



1 KUTUPLU DAĞITICI ÜNİTELER (6.5 x 9 mm) 80 AMPER

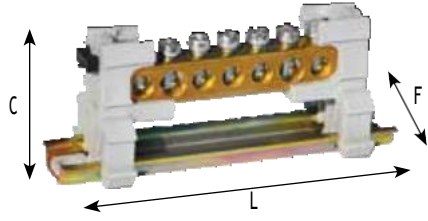

Kablo kesiti max. 10 mm²
(Çok Telli) - 16 mm² (Tek
Damar)

KOD	CİNSİ	L	F	C	K. AD.
2051	2 / 5 7 Delikli	56.5	24	28.2	32
2052	2 / 8 10 Delikli	75	24	28.2	24
2053	2 / 10 12 Delikli	87.5	24	28.2	18
2054	2 / 13 15 Delikli	106	24	28.2	16
2055	2 / 20 22 Delikli	150	24	28.2	12

1 KUTUPLU DAĞITICI ÜNİTELER (6.5 x 9 mm) 80 AMPER (Kapaklı Sistem)



Kablo kesiti max. 10 mm²
(Çok Telli) - 16 mm² (Tek
Damar)

KOD	CİNSİ	L	F	C	K. AD.
2061	2 / 5 7 Delikli	56.5	24	36	32
2062	2 / 8 10 Delikli	75	24	36	24
2063	2 / 10 12 Delikli	87.5	24	36	18
2064	2 / 13 15 Delikli	106	24	36	16
2065	2 / 20 22 Delikli	150	24	36	12

1 KUTUPLU DAĞITICI ÜNİTELER (7 x 12 mm) 160 AMPER

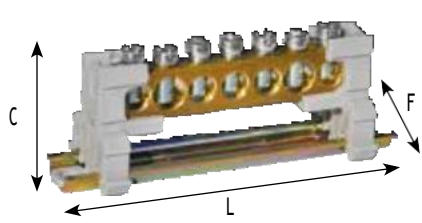

Kablo kesiti max. 25 mm²
tek damar ve çok telli

KOD	CİNSİ	L	F	C	K. AD.
2056	2 / 5 7 Delikli	68.1	24	28.2	32
2057	2 / 8 10 Delikli	91.8	24	28.2	24
2058	2 / 10 12 Delikli	107.6	24	28.2	18
2059	2 / 13 15 Delikli	131.2	24	28.2	16
2060	2 / 20 22 Delikli	186	24	28.2	12

1 KUTUPLU DAĞITICI ÜNİTELER (7 x 12 mm) 160 AMPER (Kapaklı Sistem)

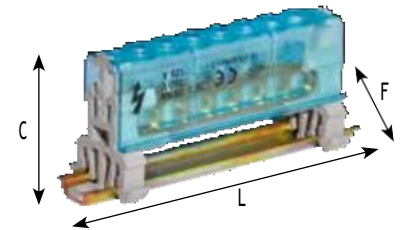

Kablo kesiti max. 25 mm²
tek damar ve çok telli

KOD	CİNSİ	L	F	C	K. AD.
2071	2 / 5 7 Delikli	68.1	24	36	32
2072	2 / 8 10 Delikli	91.8	24	36	24
2073	2 / 10 12 Delikli	107.6	24	36	18
2074	2 / 13 15 Delikli	131.2	24	36	16
2075	2 / 20 22 Delikli	186	24	36	12

1 KUTUPLU DAĞITICI ÜNİTELER (10 x 15 mm) 250 AMPER

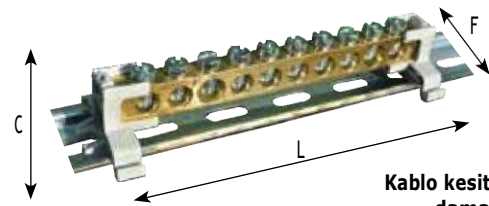

Kablo kesiti max. 50 mm² tek
damar ve çok telli

KOD	CİNSİ	L	F	C	K. AD.
2066	2 / 5 7 Delikli	107	43.2	39	32
2067	2 / 8 10 Delikli	145	43.2	39	24
2068	2 / 10 12 Delikli	170	43.2	39	18
2069	2 / 13 15 Delikli	206.5	43.2	39	16
2070	2 / 20 22 Delikli	294	43.2	39	12

1 KUTUPLU DAĞITICI ÜNİTELER (10 x 15 mm) 250 AMPER (Kapaklı Sistem)

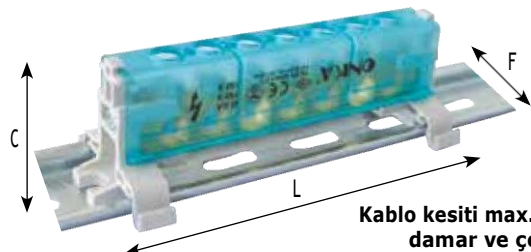

Kablo kesiti max. 50 mm² tek
damar ve çok telli

KOD	CİNSİ	L	F	C	K. AD.
2076	2 / 5 7 Delikli	107	43.2	39	32
2077	2 / 8 10 Delikli	145	43.2	39	24
2078	2 / 10 12 Delikli	170	43.2	39	18
2079	2 / 13 15 Delikli	206.5	43.2	39	16
2080	2 / 20 22 Delikli	294	43.2	39	12

2 KUTUPLU DAĞITICI ÜNİTELER (6.5 x 9 mm) 80 AMPER

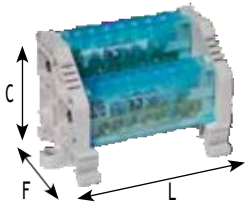

Kablo kesiti max. 10 mm² (Çok Telli)
- 16 mm² (Tek Damar)

KOD	CİNSİ	L	F	C	K. AD.
2081	2 / 5 7 Delikli	67.5	41.7	50.8	1
2082	2 / 8 10 Delikli	86.5	41.7	50.8	1
2083	2 / 10 12 Delikli	99	41.7	50.8	1
2084	2 / 13 15 Delikli	117.5	41.7	50.8	1
2085	2 / 20 22 Delikli	161.3	41.7	50.8	1

t

2 KUTUPLU DAĞITICI ÜNİTELER (7 x 12 mm) 160 AMPER

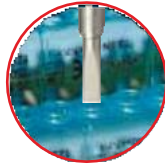
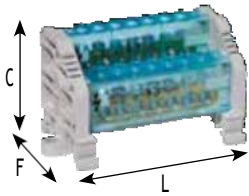

Kapak sökmeden
montajlama avantajı

KOD	CİNSİ	L	F	C	K. AD.
2091	2 / 5 7 Delikli	80	41.7	50.8	1
2092	2 / 8 10 Delikli	103.5	41.7	50.8	1
2093	2 / 10 12 Delikli	119	41.7	50.8	1
2094	2 / 13 15 Delikli	142	41.7	50.8	1
2095	2 / 20 22 Delikli	197	41.7	50.8	1

t

2 KUTUPLU DAĞITICI ÜNİTELER (10 x 15 mm) 250 AMPER

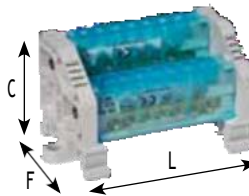

Kablo kesiti max.
50 mm² tek damar ve çok telli

KOD	CİNSİ	L	F	C	K. AD.
2086	2 / 5 7 Delikli	117	55.0	50.8	1
2087	2 / 8 10 Delikli	154.5	55.0	50.8	1
2088	2 / 10 12 Delikli	179	55.0	50.8	1
2089	2 / 13 15 Delikli	217	55.0	50.8	1
2090	2 / 20 22 Delikli	304.5	55.0	50.8	1

t

3 KUTUPLU DAĞITICI ÜNİTELER (6.5 x 9 mm) 80 AMPER (Alçak Model)

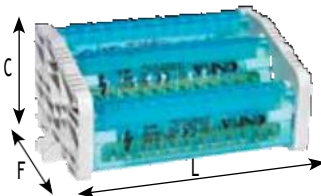

KOD	CİNSİ	L	F	C	K. AD.
2171	2 / 5 7 Delikli	67.7	66	47	1
2172	2 / 8 10 Delikli	86.6	66	47	1
2173	2 / 10 12 Delikli	98.9	66	47	1
2174	2 / 13 15 Delikli	117.8	66	47	1
2175	2 / 20 22 Delikli	161.5	66	47	1

t

3 KUTUPLU DAĞITICI ÜNİTELER (7 x 12 mm) 160 AMPER (Alçak Model)

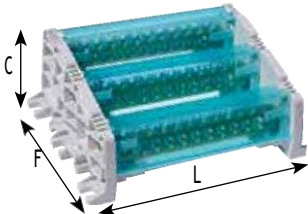

Kablo kesiti max. 25 mm²
tek damar ve çok telli

KOD	CİNSİ	L	F	C	K. AD.
2151	2 / 5 7 Delikli	80	66	47	1
2152	2 / 8 10 Delikli	103.5	66	47	1
2153	2 / 10 12 Delikli	119	66	47	1
2154	2 / 13 15 Delikli	142	66	47	1
2155	2 / 20 22 Delikli	197	66	47	1

t

3 KUTUPLU DAĞITICI ÜNİTELER (10 x 15 mm) 250 AMPER (Alçak Model)

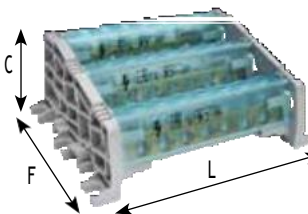

Kablo kesiti max. 50 mm²
tek damar ve çok telli

KOD	CİNSİ	L	F	C	K. AD.
2181	2 / 5 7 Delikli	117	94.5	50	1
2182	2 / 8 10 Delikli	154.5	94.5	50	1
2183	2 / 10 12 Delikli	179	94.5	50	1
2184	2 / 13 15 Delikli	217	94.5	50	1
2185	2 / 20 22 Delikli	304.5	94.5	50	1

t

3 KUTUPLU DAĞITICI ÜNİTELER (10 x 15 mm) 250 AMPER (Yüksek Model)

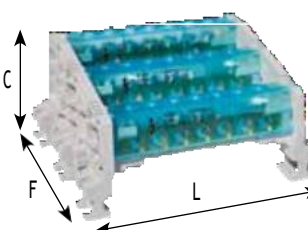

Kablo kesiti max. 50 mm² tek
damar ve çok telli

KOD	CİNSİ	L	F	C	K. AD.
2186	2 / 5 7 Delikli	117	94.5	65	1
2187	2 / 8 10 Delikli	154.5	94.5	65	1
2188	2 / 10 12 Delikli	179	94.5	65	1
2189	2 / 13 15 Delikli	217	94.5	65	1
2190	2 / 20 22 Delikli	304.5	94.5	65	1

t

4 KUTUPLU DAĞITICI ÜNİTELER (6.5 x 9 mm) 80 AMPER (Alçak Model)

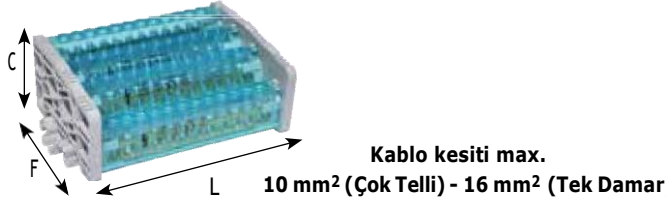

KOD	CİNSİ	L	F	C	K. AD.
2201	2 / 5 7 Delikli	67.8	86	49	1
2202	2 / 8 10 Delikli	86.7	86	49	1
2203	2 / 10 12 Delikli	99	86	49	1
2204	2 / 13 15 Delikli	117.9	86	49	1
2205	2 / 20 22 Delikli	161.6	86	49	1

4 KUTUPLU DAĞITICI ÜNİTELER (7 x 12 mm) 160 AMPER (Alçak Model)



KOD	CİNSİ	L	F	C	K. AD.
2211	2 / 5 7 Delikli	79.7	86	49	1
2212	2 / 8 10 Delikli	103.2	86	49	1
2213	2 / 10 12 Delikli	118.7	86	49	1
2214	2 / 13 15 Delikli	141.7	86	49	1
2215	2 / 20 22 Delikli	196.7	86	49	1

4 KUTUPLU DAĞITICI ÜNİTELER (10 x 15 mm) 250 AMPER

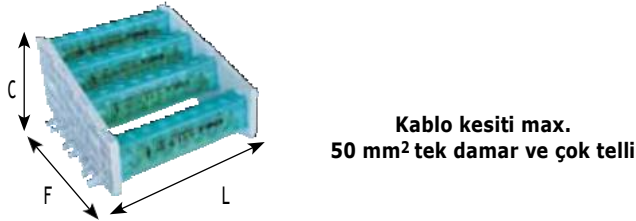

KOD	CİNSİ	L	F	C	K. AD.
2116	2 / 5 7 Delikli	124.5	130	68	1
2117	2 / 8 10 Delikli	162	130	68	1
2118	2 / 10 12 Delikli	186.5	130	68	1
2119	2 / 13 15 Delikli	224.5	130	68	1
2120	2 / 20 22 Delikli	312	130	68	1

4 KUTUPLU DAĞITICI ÜNİTELER (6.5 x 9 mm) 80 AMPER (Yüksek Model)

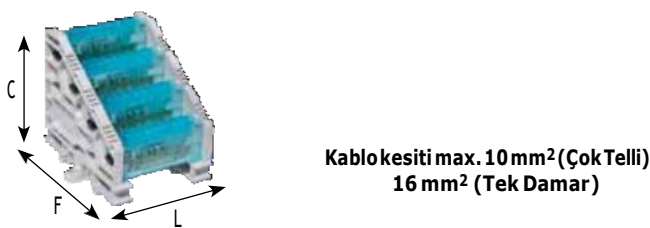

KOD	CİNSİ	L	F	C	K. AD.
2101	2 / 5 7 Delikli	67.3	86.2	87.2	1
2102	2 / 8 10 Delikli	86.2	86.2	87.2	1
2103	2 / 10 12 Delikli	98.5	86.2	87.2	1
2104	2 / 13 15 Delikli	117.4	86.2	87.2	1
2105	2 / 20 22 Delikli	161.1	86.2	87.2	1

4 KUTUPLU DAĞITICI ÜNİTELER (7 x 12 mm) 160 AMPER (Yüksek Model)

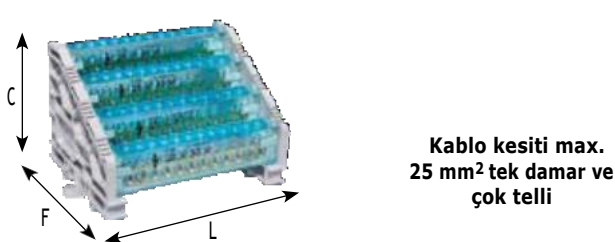

KOD	CİNSİ	L	F	C	K. AD.
2111	2 / 5 7 Delikli	78.5	86.2	82.3	1
2112	2 / 8 10 Delikli	102.5	86.2	82.3	1
2113	2 / 10 12 Delikli	118	86.2	82.3	1
2114	2 / 13 15 Delikli	141	86.2	82.3	1
2115	2 / 20 22 Delikli	196	86.2	82.3	1

5 KUTUPLU DAĞITICI ÜNİTELER (10 x 15 mm) 250 AMPER

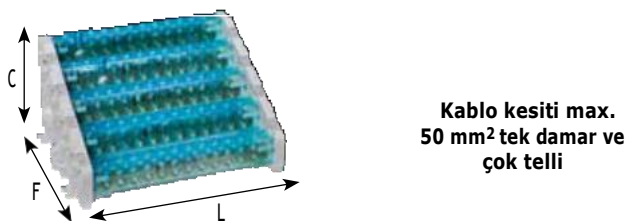

KOD	CİNSİ	L	F	C	K. AD.
2191	2 / 5 7 Delikli	124.5	149.5	96	1
2192	2 / 8 10 Delikli	162	149.5	96	1
2193	2 / 10 12 Delikli	186.5	149.5	96	1
2194	2 / 13 15 Delikli	224.5	149.5	96	1
2195	2 / 20 22 Delikli	312	149.5	96	1

5 KUTUPLU DAĞITICI ÜNİTELER (10 x 15 mm) 250 AMPER (Yüksek Model)

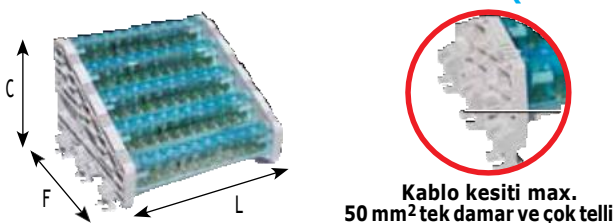

KOD	CİNSİ	L	F	C	K. AD.
2216	2 / 5 7 Delikli	124.5	149.5	111	1
2217	2 / 8 10 Delikli	162	149.5	111	1
2218	2 / 10 12 Delikli	186.5	149.5	111	1
2219	2 / 13 15 Delikli	224.5	149.5	111	1
2220	2 / 20 22 Delikli	312	149.5	111	1

5 KADEMELİ BARALI DAĞITICI ÜNİTE (10 x 15 mm) 150 AMPER

Sipariş Kodu	Cinsi	L	A	B	Kutu Adedi	⌘
2121	2 / 5 7 Delikli	124.5	90	96	1	
2122	2 / 8 10 Delikli	162	90	96	1	
2123	2 / 10 12 Delikli	187	90	96	1	
2124	2 / 13 15 Delikli	224.5	90	96	1	
2125	2 / 20 22 Delikli	312	90	96	1	

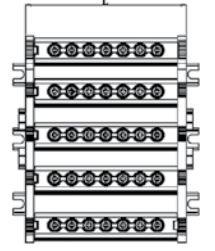
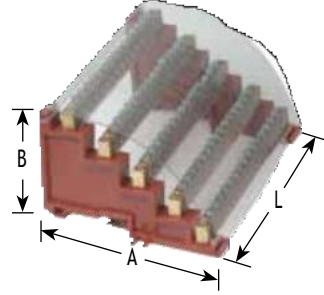

Kablo kesiti max. 50 mm²

5 KADEMELİ 30 x 5 BAKIR BARALI DAĞITICI ÜNİTE

Sipariş Kodu	Cinsi	Kutu Adedi	⌘
2135	Max. 30 x 5 Bakır Baralı istenilen uzunlukta üretilir.	1	



30 x 5 bakır bara yatağı

5 KADEMELİ 30 x 5 BAKIR BARA DAĞITICI ÜNİTELER VE AKSESUARI

Sipariş Kodu	Cinsi	Kutu Adedi	⌘
2131	5 Katlı Dağıtıcı Ünite (Max. 30x5) Yatak	10	
2132	İzasyon Separatörü	1 mt.	
2133	Üst İzalasyon Kapak	1	

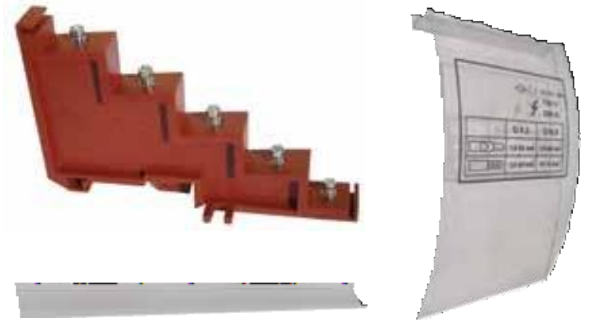

DAĞITICI ÜNİTE YÜKSELTİCİ AYAKLARI

Sipariş Kodu	Cinsi	Kutu Adedi	⌘
2134	1 - 3 - 5'li dağıtıcı üniteler için YÜKSELTME ayakları	100	



DAĞITICI ÜNİTE ALT İZOLASYON APARATI

Sipariş Kodu	Cinsi	Kutu Adedi	⌘
2137	35 mm örtme aparatı (1 m)	10	



BAKIR BARA BAĞLANTI KLEMENSİ (YAY BASKILI) 16 mm²

Sipariş Kodu	Cinsi	Kutu Adedi	ت
2140	SK16 F5 Bakır Bara Klemensi 1.5 - 16 mm ²	100	
2141	SK16F10 Bakır Bara Klemensi 1.5 - 16 mm ²	100	

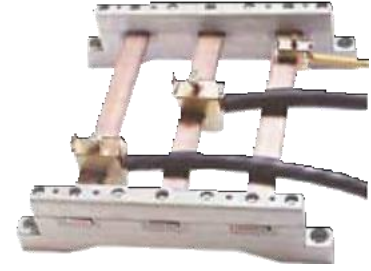
BAKIR BARA BAĞLANTI KLEMENSİ (YAY BASKILI) 35 mm²

Sipariş Kodu	Cinsi	Kutu Adedi	ت
2142	SK35 F5 Bakır Bara Klemensi 1.5 - 35 mm ²	50	
2143	SK35F10 Bakır Bara Klemensi 1.5 - 35 mm ²	50	

BAKIR BARA BAĞLANTI KLEMENSİ (YAY BASKILI) 70 mm²

Sipariş Kodu	Cinsi	Kutu Adedi	ت
2144	SK70 F5 Bakır Bara Klemensi 16 - 70 mm ²	10	
2145	SK70F10 Bakır Bara Klemensi 16 - 70 mm ²	10	

BAKIR BARA BAĞLANTI KLEMENSİ (YAY BASKILI) 120 mm²

Sipariş Kodu	Cinsi	Kutu Adedi	ت
2146	SK120 F5 Bakır Bara Klemensi 16 - 120 mm ²	10	
2147	SK120F10 Bakır Bara Klemensi 16 - 120 mm ²	10	

GEÇMELİ BAKIR BARA BAĞLANTI KLEMENSLERİ (PALETLİ SİSTEM)

Sipariş Kodu	Cinsi	Kutu Adedi	ت
2160	SK12 F3 Bakır Bara Klemensi 16 mm ²	300	
2161	SK12 F3 Bakır Bara Klemensi 35 mm ²	250	
2162	12 x 3 mm Elektrolitik Bakır Bara	1 mt.	





35x7,5 GALVANİZ KAPLI DÜZ SAC MONTAJ RAYLARI

Sipariş Kodu	Cinsi	Kutu Ad.	t
4211	30 cm	100	
4212	1 m	50	
4213	2 m	50	

35 x 7,5 GALVANİZ KAPLI DELİKLİ SAC MONTAJ RAYLARI

Sipariş Kodu	Cinsi	Kutu Ad.	t
4221	30 cm	100	
4222	1 m	50	
4223	2 m	50	

35x15 GALVANİZ KAPLI DÜZ SAC MONTAJ RAYLARI

Sipariş Kodu	Cinsi	Kutu Ad.	t
4231	30 cm	100	
4232	1 m	25	
4233	2 m	25	

35 x 15 GALVANİZ KAPLI DELİKLİ SAC MONTAJ RAYLARI

Sipariş Kodu	Cinsi	Kutu Ad.	t
4241	30 cm	100	
4242	1 m	25	
4243	2 m	25	

RAY TAŞIYICILAR (SACCR+3)

Sipariş Kodu	Cinsi	Kutu Ad.	t
4172	Ray Taşıyıcı Sac Krom	100	

RAY TAŞIYICILAR ALÜMİNYUM

Sipariş Kodu	Cinsi	Kutu Ad.	t
4161	Ray Taşıyıcı ALÜMİNYUM	100	

U PROFİL DESTEKRAYI (Cr3)



Sipariş Kodu	Cinsi	Kutu Ad.	t
4191	1 Metre U Profil (Cr3)	25	
4192	2 Metre U Profil (Cr3)	25	
4193	3 Metre U Profil (Cr3)	25	

KÖŞE APARATI (PANO KAPAKLARI İÇİN)



Sipariş Kodu	Cinsi	Kutu Ad.	t
4195	Sağ Sol Köşe Aparatı	100	

U KLEMENSLER

Sipariş Kodu	Cinsi	Kutu Adedi	⌘
7050	6'lık U Klemens	300	
7051	10'luk U Klemens	250	
7052	16'lık U Klemens	150	
7053	25'lik U Klemens	100	
7054	35'lik U Klemens	75	
7055	50'lik U Klemens	50	
7056	70'lik U Klemens	40	
7057	95'lik U Klemens	30	
7058	120'lik U Klemens	20	
7059	150'lik U Klemens	10	
7060	U Klemens Kayığı	100	

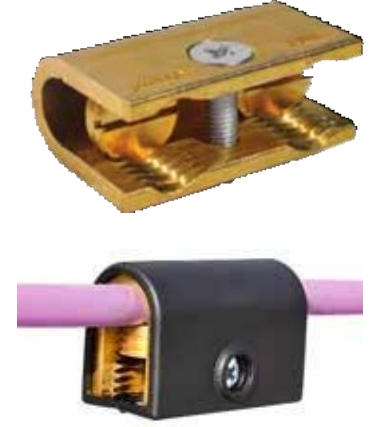

TIRNAKLI KLEMENSLER

Sipariş Kodu	Cinsi	Kutu Adedi	⌘
7070	No. 1 16 mm ²	500	
7071	No. 2 25 mm ²	250	
7072	No. 3 35 mm ²	100	
7073	No. 4 50 mm ²	100	
7074	No. 5 70 mm ²	100	
7075	No. 6-7 120 mm ²	50	



C KLEMENSLER

Sipariş Kodu	Cinsi	Sıkma Sahası (mm ²)	Kullanılacağı İletkenler	Kutu Adedi	⌘
7061	CK01 16 - 25	18	16	50	
7062	CK02 25 - 35	27	20	50	
7063	CK03 35 - 50	32	25	50	
7064	CK04 50 - 70	41	30	50	
7065	CK05 70 - 95	45	35	50	
7066	CK06 95 - 120	60	40	50	
7067	CK07 120 - 150	65	45	50	

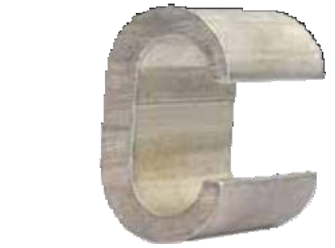

H KLEMENSLER

Sipariş Kodu	Cinsi	Sıkma Sahası (mm ²)	Kullanılacağı İletkenler	Kutu Adedi	⌘
7068	H16-25-35-50-70 95-120	30	22	50	

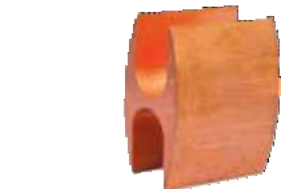

KAPAKLI TERMİNAL KLEMENSLER 25 A

Sipariş Kodu	Cinsi	Kutu Adedi	⌘
5145	25 A. 600V Terminal-3	50	
5146	25 A. 600V Terminal-4	50	
5147	25 A. 600V Terminal-6	50	
5148	25 A. 600V Terminal-12	25	

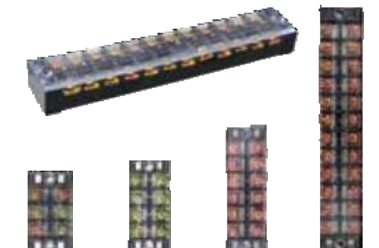

TRAFO KLEMENSLERİ VE ETİKETLERİ

Sipariş Kodu	Cinsi	Kutu Adedi	₺
5135	1x4 mm ² YüksekTip / 24A / 400V	200	
5136	2x4 mm ² YüksekTip / 24A / 400V	100	
5137	1x6 mm ² YüksekTip / 24A / 400V	100	
5139	Trafo Klemens Etik. Yazısız	500	
5140	Trafo Klemens Etiketi Yazılı	500	

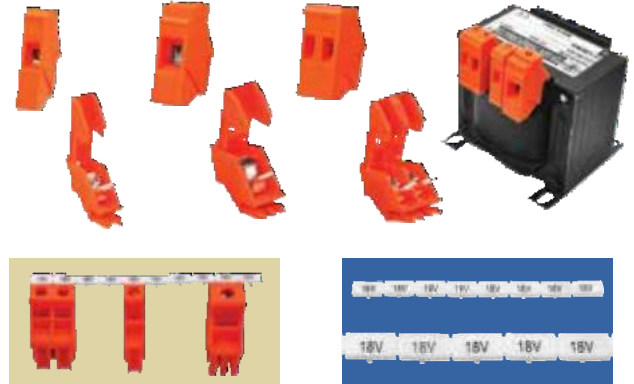

MODÜL CİHAZ KLEMENSLERİ (PALETLİ KALAY KAPLAMALI DEKAFIX'LI ÇİFT RENKLİ)

Sipariş Kodu	Cinsi	Kutu Adedi	₺
5100	No.1 (2,5 - 4 mm ²), 32 A / 400 V	250	
5101	No.2 (4 - 6 mm ²), 41 A / 400 V	144	
5102	No.3 (6 - 10 mm ²), 57 A / 400 V	75	
5103	No.1-3'lü (2,5 - 4 mm ²), 32 A / 400V	200	



STEATİT KLEMENSLER

Sipariş Kodu	Cinsi	Kutu Adedi	₺
5081	No. 0 2'li Steatit Klemens	150	
5082	No. 1 2'li Steatit Klemens	150	
5083	No. 1 3'lü Steatit Klemens	100	
5084	No. 2 2'li Steatit Klemens	100	
5085	No.2 3'lü Steatit Klemens	50	
5086	No. 3 2'li Steatit Klemens	50	
5087	No.3 3'lü Steatit Klemens	35	
5088	No. 0 1'li Steatit Klemens	400	
5089	No. 1 1'li Steatit Klemens	350	
5090	No. 2 1'li Steatit Klemens	200	
5091	No. 3 1'li Steatit Klemens	100	
5096	Steatit Klemens Kapağı	100	
5093	No.4 3'lü Steatit Klemens (Kondansatör için)	20	
5094	No.5 3'lü Steatit Klemens (Kondansatör için)	20	

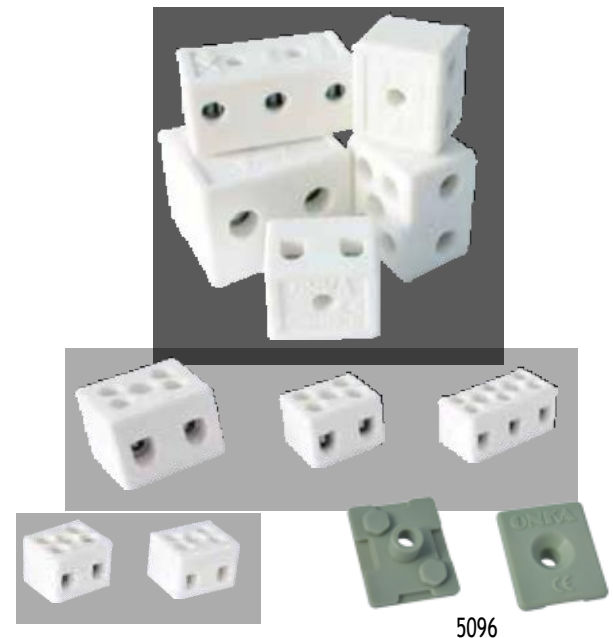

MİNİ KLEMENS (Aspiratör Klemensi)

Sipariş Kodu	Cinsi	Kutu Adedi	₺
5130	Mini Klemens (Aspiratör) 2.5 - 4 mm ² 400 V - 32 A	250	



PLASTİK SIRA KLEMENSLER, VİDA BLOKAJLI - (MAVİ)

Sipariş Kodu	Cinsi	Volt	Amper	Kutu Adedi	⌘
5000	No. 0 0.75 - 1.5 mm ² 'lik 12 Sıra	400	17.5	100	
5001	No. 1 2.5 - 4 mm ² 'lik 12 Sıra	400	32	50	
5002	No. 2 4 - 6 mm ² 'lik 12 Sıra	400	41	50	
5003	No. 3 6 - 10 mm ² 'lik 10 Sıra	400	57	50	
5004	No. 4 10 - 16 mm ² 'lik 6 Sıra	500	76	50	
5005	No. 5 16 - 25 mm ² 'lik 6 Sıra	500	101	50	

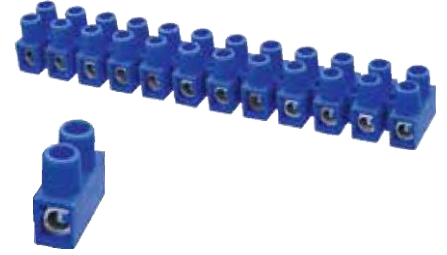
ISIYA DAYANIKLI PLASTİK, VİDA BLOKAJLI - (BEYAZ - KIRMIZI) V2, TSE, OSK

Sipariş Kodu	Cinsi	Volt	Amper	Kutu Adedi	⌘
5010	No. 0 0.75 - 1.5 mm ² 'lik 12 Sıra	400	17.5	100	
5011	No. 1 2.5 - 4 mm ² 'lik 12 Sıra	400	32	50	
5012	No. 2 4 - 6 mm ² 'lik 12 Sıra	400	41	50	
5013	No. 3 6 - 10 mm ² 'lik 10 Sıra	400	57	50	
5014	No. 4 10 - 16 mm ² 'lik 6 Sıra	500	76	50	
5015	No. 5 16 - 25 mm ² 'lik 6 Sıra	500	101	50	
5016	No. 3 3'LÜ 6 - 10 mm ² 'lik	400	57	50	

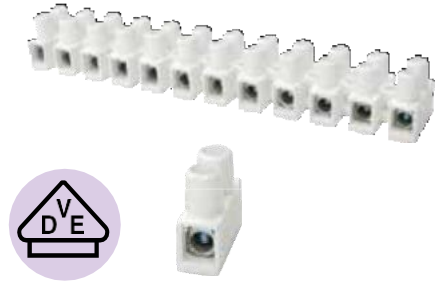
ISIYA DAYANIKLI PLASTİK, VİDA BLOKAJLI - (ŞEFFAF - POLİKARBON)

Sipariş Kodu	Cinsi	Volt	Amper	Kutu Adedi	⌘
5020	No. 0 0.75 - 1.5 mm ² 'lik 12 Sıra	400	17.5	100	
5021	No. 1 2.5 - 4 mm ² 'lik 12 Sıra	400	32	50	
5022	No. 2 4 - 6 mm ² 'lik 12 Sıra	400	41	50	
5023	No. 3 6 - 10 mm ² 'lik 10 Sıra	400	57	50	
5024	No. 4 10 - 16 mm ² 'lik 6 Sıra	500	76	50	
5025	No. 5 16 - 25 mm ² 'lik 6 Sıra	500	101	50	
5026	No. 3 3'LÜ 6 - 10 mm ² 'lik	400	57	50	

PANO İÇİ YÜKSEK ISIYA DAYANIKLI, VİDA BLOKAJLI - (200° HA66-VO)

Sipariş Kodu	Cinsi	Volt	Amper	Kutu Adedi	⌘
5029	No. 0 0.75 - 1.5 mm ² 'lik 12 Sıra	400	17.5	100	
5030	No. 1 2.5 - 4 mm ² 'lik 12 Sıra	400	32	50	
5031	No. 2 4 - 6 mm ² 'lik 12 Sıra	400	41	50	
5032	No. 3 6 - 10 mm ² 'lik 10 Sıra	400	57	50	
5033	No. 4 10 - 16 mm ² 'lik 6 Sıra	500	76	50	
5034	No. 5 16 - 25 mm ² 'lik 6 Sıra	500	101	50	
5035	No. 3 3'LÜ 6 - 10 mm ² 'lik	400	57	50	

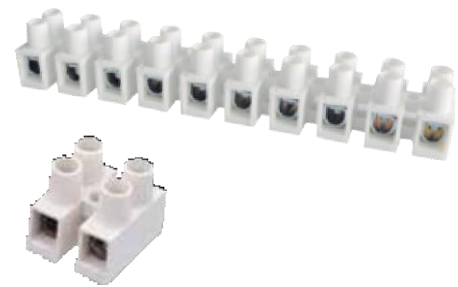
PALETLİ ISIYA DAYANIKLI, VİDA BLOKAJLI - (BEYAZ - KIRMIZI) 140 °C V2

Sipariş Kodu	Cinsi	Volt	Amper	Kutu Adedi	⌘
5040	No. 1 2.5 - 4 mm ² 'lik 12 Sıra	400	32	50	
5041	No. 2 4 - 6 mm ² 'lik 12 Sıra	400	41	50	
5042	No. 3 6 - 10 mm ² 'lik 10 Sıra	400	57	50	
5043	No. 3 3'LÜ 6 - 10 mm ² 'lik	400	57	50	

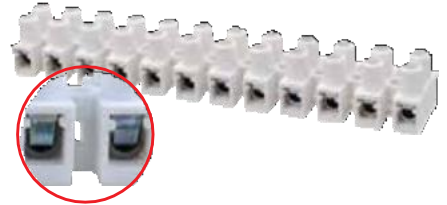
PALETLİ ISIYA DAYANIKLI, VİDA BLOKAJLI - (ŞEFFAF - POLİKARBON)

Sipariş Kodu	Cinsi	Volt	Amper	Kutu Adedi	⌘
5050	No. 1 2.5 - 4 mm ² 'lik 12 Sıra	400	32	50	
5051	No. 2 4 - 6 mm ² 'lik 12 Sıra	400	41	50	
5052	No. 3 6 - 10 mm ² 'lik 10 Sıra	400	57	50	
5053	No. 3 3'LÜ 6 - 10 mm ² 'lik	400	57	50	



PALETLİ YÜKSEK ISIYA DAYANIKLI, VİDA BLOKAJLI - (200 °C - HA66-V0)

Sipariş Kodu	Cinsi	Volt	Amper	Kutu Adedi	⌘
5056	No. 1 2.5 - 4 mm ² 'lik 12 Sıra	400	32	50	
5057	No. 2 4 - 6 mm ² 'lik 12 Sıra	400	41	50	
5058	No. 3 6 - 10 mm ² 'lik 10 Sıra	400	57	50	
5059	No. 3 3'lü 6 - 10 mm ² 'lik	400	57	50	

12'Lİ SOKET KLEMENS

Sipariş Kodu	Cinsi	Kutu Adedi	⌘
5060	No. 1-12 2.5 - 4 mm ² 'lik (Erkek Dişi Geçmeli Kilitli) (İstenilen Modül sayısında kesim yapılır.)	30	

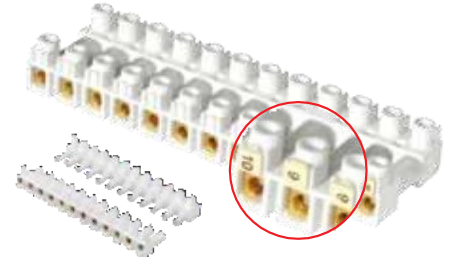
2'Lİ MODÜLER SİSTEM SOKET KLEMENSLER

Sipariş Kodu	Cinsi	Kutu Adedi	⌘
5068	NO. 1 - 2'li Soket Klemensi + Modüler Sistem	180	

3'LÜ SOKET KLEMENS

Sipariş Kodu	Cinsi	Kutu Adedi	⌘
5065	No.1 3'lü Soket Klemensi	100	
5066	Soket Klemensi Kapağı (Takım)	45	
5067	No.1 3'lü Soket Klemensi + Kapak Takımı	45	

3'LÜ SOKET KLEMENS T BAĞLANTI APARATI

Sipariş Kodu	Cinsi	Kutu Adedi	⌘
5074	2.5 - 4 mm ² T Bağlantı Aparatı	60	

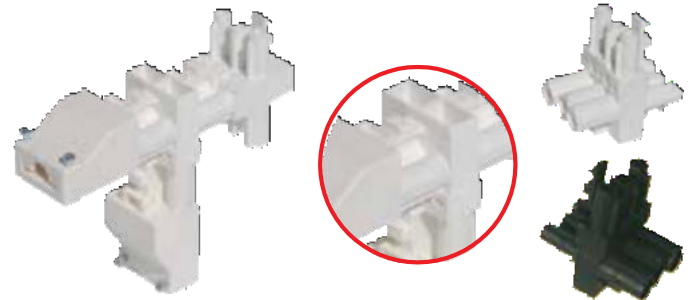
6'Lİ SOKET KLEMENS BAĞLANTI APARATI

Sipariş Kodu	Cinsi	Kutu Adedi	⌘
5064 Beyaz	No:1, 2.5 - 4 mm ² 6'li soket kapak takım	16	
5063 Siyah	No:1, 2.5 - 4 mm ² 6'li soket kapak takım	16	



METRELİK PANO ETİKETİ (YAPIŞKANLI)

Sipariş Kodu	Cinsi	Kutu Adedi	t
7126	15 x 100 cm Yapışkanlı Pano Etiketi	50	



PANO ETİKETLERİ (YAPIŞKANLI ve VİDALI)

Sipariş Kodu	Cinsi	Kutu Adedi	t
7114	17 x 30 mm Pano Etiketi	100	
7115	17 x 52 mm Pano Etiketi	100	
7116	17 x 70 mm Pano Etiketi	50	



W OTOMAT ÖRTME APARATI

Sipariş Kodu	Cinsi	Kutu Adedi	t
7121	W Otomat Örtme Aparatı	50	



RENKLER

RAL 9001

RAL 7035

RAL 7033

KC TİP KABLO NUMARALAMALARI (KABLOYA ÜSTTEN GEÇMELİ)



Sipariş Kodu	Cinsi	Kutu Ad.	t
9850	0,50 x 1 mm ² Rakam	400/20.000	
9894	1,50 x 2,50 mm ² Rakam	400/20.000	
9942	4,0 x 6,00 mm ² Rakam	400/20.000	
9851	0,50 x 1 mm ² Yazı	400/20.000	
9895	1,50 x 2,50 mm ² Yazı	400/20.000	
9943	4,0 x 6,00 mm ² Yazı	400/20.000	

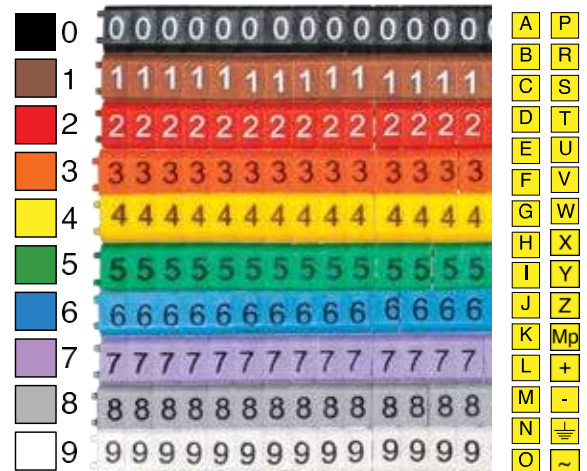

LOOBAR®

ELEKTRİK DAĞITIM VE EK ÇÖZÜMLERİ



ERICO



ZEMİNE MONTAJ TOPRAK BARALARI



63 AMPER TOPRAK BARALARI (6,5 x 9 mm)

Sipariş Kodu	Açıklama	Giriş	Çıkış	Giriş Kablo Ø	Çıkış Kablo Ø	Uzunluk (mm)	Paket Ad.
LB.104.050.T	1+4 T63	1	4	10	6	45	12
LB.105.063.T	1+5 T63	1	5	10	6	58	12
LB.209.063.T	2+9 T63	2	9	10	6	92	12
LB.210.063.T	2+10 T63	2	10	10	6	85	12
LB.213.063.T	2+13 T63	2	13	10	6	129	6
LB.424.063.T	4+24 T63	4	24	10	6	195	6



80 AMPER TOPRAK BARALARI (7 x 11 mm)

Sipariş Kodu	Açıklama	Giriş	Çıkış	Giriş Kablo Ø	Çıkış Kablo Ø	Uzunluk (mm)	Paket Ad.
LB.105.080.T	1+5 T80	1	5	16	1x10+4x6	60	12
LB.208.080.T	2+8 T80	2	8	16	2x10+6x6	92	12
LB.212.080.T	2+12 T80	2	12	16	10	129	6
LB.418.080.T	4+18 T80	4	18	16	10	195	6



125 AMPER TOPRAK BARALARI (9 x 12 mm)

Sipariş Kodu	Açıklama	Giriş	Çıkış	Giriş Kablo Ø	Çıkış Kablo Ø	Uzunluk (mm)	Paket Ad.
LB.104.125.T	1+4 T125	1	4	16	1x16+3x10	60	12
LB.206.125.T	2+6 T125	1	7	25	4x16+3x10	90	12
LB.209.125.T	2+9 T125	2	9	25	16	129	6
LB.212.125.T	2+12 T125	2	12	25	16	150	6
LB.216.125.T	2+16 T125	2	16	25	16	195	6



100 AMPER İKİ KATLI TOPRAK BARALARI

Sipariş Kodu	Açıklama	Giriş	Çıkış	Giriş Kablo Ø	Çıkış Kablo Ø	Uzunluk (mm)	Paket Ad.
LB.213.100.TC	2+13 TC100	2	13	10	6	85	6
LB.223.100.TC	2+23 TC100	2	23	10	6	110	6



63 AMPER AYAKLI TOPRAK BARALARI (6,5 x 9 mm)

Sipariş Kodu	Açıklama	Giriş	Çıkış	Giriş Kablo Ø	Çıkış Kablo Ø	Uzunluk (mm)	Paket Ad.
LB.210.050.T	2+10 TD63	2	10	10	10	83	12



63 AMPER AYAKLI TOPRAK BARALARI (6,5 x 9 mm)

Sipariş Kodu	Açıklama	Giriş	Çıkış	Giriş Kablo Ø	Çıkış Kablo Ø	Uzunluk (mm)	Paket Ad.
TY.210.063	2+10 TU63	2	10	10	6	236	6
NT.210.063	2 x (2+10) TU63	2x2	2x10	10	6	236	6
TY.420.063	4+20 TU63	4	20	10	6	236	6
TY.426.063	4+26 TU63	4	26	10	6	236	6



1 METRE NÖTR VE TOPRAK BARALARI

Sipariş Kodu	Açıklama	Giriş	Çıkış	Giriş Kablo Ø	Çıkış Kablo Ø	Uzunluk (mm)	Paket Ad.
LB.215.063.TMT	6,5 x 9 TMT	20	142	6	6	1000	6
LB.213.080.TMT	7 x 11 TMT	20	102	16	10	1000	6
LB.208.125.TMT	9 x 12 TMT	10	81	16	16	1000	6



1 METRE TOPRAK BARALARI İÇİN AYAKLAR

Sipariş Kodu	Açıklama	Paket Ad.
RPA.063	6,5 x 9 mm için ayak	24
RPA.080	7 x 11 mm için ayak	24
RPA.125	9 x 12 mm için ayak	24



160 AMPER TOPRAK BARALARI (11 x 15 mm)

Sipariş Kodu	Açıklama	Giriş	Çıkış	Giriş Kablo Ø	Çıkış Kablo Ø	Uzunluk (mm)	Paket Ad.
LB.104.160.T	1+4 T160	1	5	35	1x25-4x16	84	6
LB.406.160.T	4+6 T160	2	8	35	2x25-6x16	129	6
LB.409.160.T	4+9 T160	2	11	35	3x25-8x16	159	6
LB.612.160.T	6+12 T160	2	16	35	6x25-10x16	212	6
LB.636.160.T	6+36 T160	6	36	35	16	423	6
LB.1054.160.T	10+54 T160	10	54	35	16	650	6



Sipariş Kodu	Açıklama	Paket Ad.
RPA.160	11 x 15 mm için ayak	24



250 AMPER TOPRAK BARALARI (13 x 15 mm)

Sipariş Kodu	Açıklama	Giriş	Çıkış	Giriş Kablo Ø	Çıkış Kablo Ø	Uzunluk (mm)	Paket Ad.
LB.406.250.T	2+2+6 T250	1	9	50	2x35+2x25+5x16	129	6
LB.409.250.T	2+2+9 T250	1	12	50	2x35+4x25+6x16	168	6
LB.612.250.T	2+4+12 T250	1	17	50	3x35+4x25+10x16	212	6



250 AMPER TOPRAK BARALARI (18 x 12 mm)

Sipariş Kodu	Açıklama	Giriş	Çıkış	Giriş Kablo Ø	Çıkış Kablo Ø	Uzunluk (mm)	Paket Ad.
LB.1210.250.T	1+2+10 T250	1+2	10	1x70+2x25	16	98	6
LB.1222.250.T	1+2+22 T250	1+2	22	1x70+2x25	16	147	6
LB.1234.250.T	1+2+34 T250	1+4	34	1x70+2x25	16	196	6

ZEMİNE VE RAYA MONTAJ NÖTR BARALARI



63 AMPER NÖTR BARALARI (6,5 x 9 mm)

Sipariş Kodu	Açıklama	Giriş	Çıkış	Giriş Kablo Ø	Çıkış Kablo Ø	Uzunluk (mm)	Paket Ad.
LB.107.063.N	1+7 N63	1	7	10	6	93	12
LB.211.063.N	2+11 N63	2	11	10	6	127	12
LB.215.063.N	2+15 N63	2	15	10	6	164	6
LB.426.063.N	4+26 N63	4	26	10	6	230	6

80 AMPER NÖTR BARALARI (7 x 11 mm)

Sipariş Kodu	Açıklama	Giriş	Çıkış	Giriş Kablo Ø	Çıkış Kablo Ø	Uzunluk (mm)	Paket Ad.
LB.107.080.N	1+7 N80	1	7	16	1x10-6x6	93	12
LB.210.080.N	2+10 N80	2	10	16	2x10-8x6	127	12
LB.214.080.N	2+14 N80	2	14	16	10	164	6
LB.420.080.N	4+20 N80	4	20	16	10	230	6

125 AMPER NÖTR BARALARI (9 x 12 mm)

Sipariş Kodu	Açıklama	Giriş	Çıkış	Giriş Kablo Ø	Çıkış Kablo Ø	Uzunluk (mm)	Paket Ad.
LB.106.125.N	1+6 N125	1	6	25	1x16+5x10	93	12
LB.208.125.N	2+8 N125	1	9	25	6x16+3x10	127	12
LB.211.125.N	2+11 N125	2	11	25	16	164	6
LB.214.125.N	2+14 N125	2	14	25	16	150	6
LB.218.125.N	4+18 N125	2	18	25	16	230	6



100 AMPER İKİ KATLI NÖTR BARALARI

Sipariş Kodu	Açıklama	Giriş	Çıkış	Giriş Kablo Ø	Çıkış Kablo Ø	Uzunluk (mm)	Paket Ad.
LB.213.100.NC	2+13 NC100	2	13	16	6	115	6
LB.223.100.NC	2+23 NC100	2	23	16	6	144	6



63 AMPER NÖTR BARALARI (6,5 x 9 mm)

Sipariş Kodu	Açıklama	Giriş	Çıkış	Giriş Kablo Ø	Çıkış Kablo Ø	Uzunluk (mm)	Paket Ad.
LB.210.050.N	2+10 ND63	2	10	10	6	83	12



63 AMPER NÖTR BARALARI (6,5 x 9 mm)

Sipariş Kodu	Açıklama	Giriş	Çıkış	Giriş Kablo Ø	Çıkış Kablo Ø	Uzunluk (mm)	Paket Ad.
NM.210.063	2+10 NU63	2	10	10	6	236	6
NT.210.063	2x(2+10) NU63	2x2	2x10	10	6	236	6
NM.420.063	4+20 NU63	4	20	10	6	236	6
NM.426.063	4+26 NU63	4	26	10	6	236	6



160 AMPER NÖTR BARALARI (11 x 15 mm)

Sipariş Kodu	Açıklama	Giriş	Çıkış	Giriş Kablo Ø	Çıkış Kablo Ø	Uzunluk (mm)	Paket Ad.
LB.106.160.N	1+6 N160	1	7	35	1x25+6x16	113	6
LB.408.160.N	4+8 N160	2	10	35	2x25+8x16	164	6
LB.411.160.N	4+11 N160	2	13	35	3x25+10x16	230	6
LB.614.160.N	6+11 N160	2	18	35	6x25+12x16	249	6
LB.636.160.N	6+36 N160	6	36	35	16	458	6
LB.1054.160.N	10+54 N160	10	54	35	16	685	6



250 AMPER NÖTR BARALARI (12 x 18 mm)

Sipariş Kodu	Açıklama	Giriş	Çıkış	Giriş Kablo Ø	Çıkış Kablo Ø	Uzunluk (mm)	Paket Ad.
LB.1210.250.T	1+2+10 N250	1+2	10	1x70+2x25	16	98	6
LB.1222.250.T	1+2+22 N250	1+2	22	1x70+2x25	16	147	6
LB.1234.250.T	1+2+34 N250	1+2	34	1x70+2x25	16	196	6

ZEMİNE VE RAYA MONTAJ DAĞITICI ÜNİTELER (63-80-125 AMPER)



2 BARALI 40 - 63 AMPER

Sipariş Kodu	Açıklama	Amper	Giriş	Çıkış	Giriş Kablo Ø	Çıkış Kablo Ø	LxHxD (mm)	Paket Ad.
LB.2107.063	1+7 2P63	63	1	7	1,5-10	1-6	73 x 51 x 51	1
LB.2210.063	2+10 2P63	63	2	10	1,5-10	1-6	105 x 51 x 51	1
LB.2215.063	2+15 2P63	63	2	15	1,5-10	1-6	140 x 51 x 51	1
LB.2426.063	2+10 2P63	63	4	26	1,5-10	1-6	208 x 51 x 51	1

2 BARALI 63 - 80 AMPER

Sipariş Kodu	Açıklama	Amper	Giriş	Çıkış	Giriş Kablo Ø	Çıkış Kablo Ø	LxHxD (mm)	Paket Ad.
LB.2107.080	1+7 2P80	80	1	7	2,5-16	1,5-10	73 x 51 x 51	1
LB.2210.080	2+10 2P80	80	2	10	2,5-16	1,5-10	105 x 51 x 51	1
LB.2214.080	2+14 2P80	80	2	14	2,5-16	1,5-10	140 x 51 x 51	1
LB.2420.080	2+20 2P80	80	4	20	2,5-16	1,5-10	208 x 51 x 51	1

2 BARALI 100-125 AMPER

Sipariş Kodu	Açıklama	Amper	Giriş	Çıkış	Giriş Kablo Ø	Çıkış Kablo Ø	LxHxD (mm)	Paket Ad.
LB.2106.125	1+6 2P125	125	1	6	10-25	1,5 -16	73 x 51 x 51	1
LB.2208.125	2+8 2P125	125	2	8	10-25	1,5 -16	105 x 51 x 51	1
LB.2211.125	2+11 2P125	125	2	11	10-25	1,5 -16	140 x 51 x 51	1
LB.2218.125	2+18 2P125	125	2	18	10-25	1,5 -16	208 x 51 x 51	1



3 BARALI 40 - 63 AMPER

Sipariş Kodu	Açıklama	Amper	Giriş	Çıkış	Giriş Kablo Ø	Çıkış Kablo Ø	LxHxD (mm)	Paket Ad.
LB.3107.063	1+7 3P63	63	1	7	1,5-10	1-6	73 x 84 x 49	1
LB.3210.063	2+10 3P63	63	2	10	1,5-10	1-6	105 x 84 x 49	1
LB.3215.063	2+15 3P63	63	2	15	1,5-10	1-6	140 x 84 x 49	1
LB.3426.063	4+26 3P63	63	4	26	1,5-10	1-6	208 x 84 x 49	1

3 BARALI 63 - 80 AMPER

Sipariş Kodu	Açıklama	Amper	Giriş	Çıkış	Giriş Kablo Ø	Çıkış Kablo Ø	LxHxD (mm)	Paket Ad.
LB.3107.080	1+7 3P80	80	1	7	2,5-16	1,5-10	73 x 84 x 49	1
LB.3210.080	2+10 3P80	80	2	10	2,5-16	1,5-10	105 x 84 x 49	1
LB.3214.080	2+14 3P80	80	2	14	2,5-16	1,5-10	140 x 84 x 49	1
LB.3420.080	4+20 3P80	80	4	20	2,5-16	1,5-10	208 x 84 x 49	1

3 BARALI 100 -125 AMPER

Sipariş Kodu	Açıklama	Amper	Giriş	Çıkış	Giriş Kablo Ø	Çıkış Kablo Ø	LxHxD (mm)	Paket Ad.
LB.3106.125	1+6 3P125	125	1	6	10-25	1,5-10-1-6	73 x 84 x 49	1
LB.3208.125	2+8 3P125	125	2	8	10-25	1,5-10	105 x 84 x 49	1
LB.3211.125	2+11 3P125	125	2	11	10-25	1,5-10	140 x 84 x 49	1
LB.3214.125	2+14 3P125	125	2	14	25	16	160 x 84 x 49	1
LB.3218.125	2+18 3P125	125	2	18	10-25	1,5-10	208 x 84 x 49	1

ZEMİNE VERAYA MONTAJ DAĞITICI ÜNİTELER (160-250 AMPER)



3 BARALI 125-160 AMPER

Sipariş Kodu	Açıklama	Amper	Giriş	Çıkış	Giriş Kablo Ø	Çıkış Kablo Ø	LxHxD (mm)	Paket Ad.
LB.3104.160	1+4 3P160	160	1	4	35	16	110 x 100 x 55	1
LB.3209.160	4+6 3P160	160	4	6	35	16	160 x 100 x 55	1
LB.3409.160	4+9 3P160	160	4	9	35	16	200 x 100 x 55	1
LB.3416.160	6+12 3P160	160	6	12	35	16	245 x 100 x 55	1



3 BARALI 160-250 AMPER

Sipariş Kodu	Açıklama	Amper	Giriş	Çıkış	Giriş Kablo Ø	Çıkış Kablo Ø	LxHxD (mm)	Paket Ad.
LB.3406.250	2+2+8 3P250	250	2	2+6	50	35+16	160 x 100 x 55	1
LB.3409.250	4+9 3P250	250	2	2+9	50	35+16	200 x 100 x 55	1
LB.3612.250	2+4+12 3P250	250	2	4+12	50	35+16	245x 100 x 55	1

ZEMİNEVERAYA MONTAJ DAĞITICI ÜNİTELER (40-63-80-125-250-160 AMPER)



4 BARALI 40 - 63 AMPER

Sipariş Kodu	Açıklama	Amper	Giriş	Çıkış	Giriş Kablo Ø	Çıkış Kablo Ø	LxHxD (mm)	Paket Ad.
LB.4107.063	1+7 4P63	63	1	7	10	6	70 x 100 x 53	1
LB.4210.063	2+10 4P63	63	2	10	10	6	100 x 100 x 53	1
LB.4215.063	2+15 4P63	63	2	15	10	6	140 x 100 x 53	1
LB.4426.063	4+26 4P63	63	4	26	10	6	208 x 100 x 53	1

4 BARALI 63 - 80 AMPER

Sipariş Kodu	Açıklama	Amper	Giriş	Çıkış	Giriş Kablo Ø	Çıkış Kablo Ø	LxHxD (mm)	Paket Ad.
LB.4107.080	1+7 4P80	80	1	7	16	10	70 x 100 x 53	1
LB.4210.080	2+10 3P80	80	2	10	16	10	100 x 100 x 53	1
LB.4214.080	2+14 4P80	80	2	14	16	10	140 x 100 x 53	1
LB.4420.080	4+20 4P80	80	4	20	16	10	208 x 100 x 53	1

4 BARALI 100 - 125 AMPER

Sipariş Kodu	Açıklama	Amper	Giriş	Çıkış	Giriş Kablo Ø	Çıkış Kablo Ø	LxHxD (mm)	Paket Ad.
LB.4106.125	1+6 4P125	125	1	6	16	10	70 x 100 x 53	1
LB.4208.125	2+8 4P125	125	2	8	25	16	100 x 100 x 53	1
LB.4211.125	2+11 4P125	125	2	11	25	16	140 x 100 x 53	1
LB.4214.125	2+14 4P125	125	2	14	25	16	160 x 100 x 53	1
LB.4218.125	2+18 4P125	125	2	18	25	16	208 x 100 x 53	1

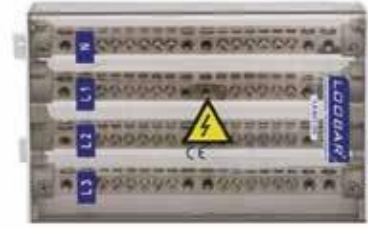

4 BARALI 125-160 AMPER

Sipariş Kodu	Açıklama	Amper	Giriş	Çıkış	Giriş Kablo Ø	Çıkış Kablo Ø	LxHxD (mm)	Paket Ad.
LB.4104.160	1+4 4P160	160	1	4	35	16	110 x 131 x 70	1
LB.4209.160	4+6 4P160	160	4	6	35	16	165 x 131 x 70	1
LB.4409.160	4+9 4P160	160	4	11	35	16	200 x 131 x 70	1
LB.4416.160	6+12 4P160	160	6	12	35	16	245 x 131 x 70	1

4 BARALI 160 - 250 AMPER

Sipariş Kodu	Açıklama	Amper	Giriş	Çıkış	Giriş Kablo Ø	Çıkış Kablo Ø	LxHxD (mm)	Paket Ad.
LB.4406.250	2+2+8 4P250	250	2	2+6	50	35+16	165 x 131 x 70	1
LB.4409.250	4+9 4P250	250	2	2+7	50	35+16	200 x 131 x 70	1
LB.4612.250	2+4+12 4P250	250	2	4+12	50	35+16	245 x 131 x 70	1

ZEMİNE VE RAYA MONTAJ TEK KUTUPLU DAĞITICILAR

160 AMPERTEK KUTUPLU DAĞITICILAR

Sipariş Kodu	Açıklama	Amp.	Giriş	Çıkış	Giriş Kablo Ø	Çıkış Kablo Ø	LxHxD (mm)	Paket Ad.
LB.114.160	1+4 KD 160	160	1	4	50	16	24x65x48	1

250 AMPERTEK KUTUPLU DAĞITICILAR

Sipariş Kodu	Açıklama	Amp.	Giriş	Çıkış	Giriş Kablo Ø	Çıkış Kablo Ø	LxHxD (mm)	Paket Ad.
LB.127.250	2+7 KD 250	250	2	7	35	3x16+4x10	38x70x48	1
LB.118.250	1+8 KD 250	250	1	8	70	3x16+4x10	38x70x48	1
LB.117.250	1+7 KD 250	250	1	7	20x5 Cu	3x16+4x10	38x70x48	1

400 AMPERTEK KUTUPLU DAĞITICILAR

Sipariş Kodu	Açıklama	Amp.	Giriş	Çıkış	Giriş Kablo Ø	Çıkış Kablo Ø	LxHxD (mm)	Paket Ad.
LB.127.400	2+7 KD 400	400	2	7	95	3x35+4x16	45x83x65	1

400 AMPERTEK KUTUPLU DAĞITICILAR

Sipariş Kodu	Açıklama	Amp.	Giriş	Çıkış	Giriş Kablo Ø	Çıkış Kablo Ø	LxHxD (mm)	Paket Ad.
LB.129.400	2+9 KD 400	400	2	9	95	2x95 + 3x35 + 4x16	46x95x82	1

ZEMİNE VE RAYA MONTAJ KOMPAKT EK SETLERİ

TEK KUTUP EK KLEMENSLERİ

Sipariş Kodu	Açıklama	Amp.	Giriş	Çıkış	Giriş Kablo Ø	Çıkış Kablo Ø	LxHxD (mm)	Paket Ad.
LB.111.200	1x16-50 KEK	200	1	1	16 - 50	16 - 50	23x55x50	1
LB.111.250	1x50-95 KEK	250	1	1	50 - 95	50 - 95	23x55x51	1
LB.122.500	2x50-95 KEK	500	2	2	50 - 95	50 - 95	45x60x60	1

İKİ KUTUP EK KLEMENSLERİ

Sipariş Kodu	Açıklama	Amp.	Giriş	Çıkış	Giriş Kablo Ø	Çıkış Kablo Ø	LxHxD (mm)	Paket Ad.
LB.211.200	2x16-50 KEK	200	2	2	16 - 50	16 - 50	45x60x60	1
LB.211.250	2x50-95 KEK	250	2	2	50 - 95	50 - 95	45x60x60	1

DÖRT KUTUP EK KLEMENSLERİ

Sipariş Kodu	Açıklama	Amp.	Giriş	Çıkış	Giriş Kablo Ø	Çıkış Kablo Ø	LxHxD (mm)	Paket Ad.
LB.411.100	4 x 16 KEK	100	4	4	6 - 16	6 - 16	45x45x40	1
LB.411.160	4 x 35 KEK	160	4	4	16 - 35	16 - 35	60x48x40	1



YENİ BİR FAZ KOMPAKT DAĞITICILAR 315 - 400 AMPER



Sipariş Kodu	Açıklama	Giriş	Çıkış	Giriş Kablo Ø	Çıkış Kablo Ø	ExBxY (mm)	Akım I Max.
LBE.1012.315	Bara Giriş / 12 Çıkış 250 - 315 Amper	1	12	30x5 Bara	10	49 x 100 x 66	315
LBE.1012.410	Bara Giriş / 12 Çıkış 400 Amper	1	12	30x5 Bara	10	49 x 100 x 66	400
LBE.1112.315	1 Giriş / 12 Çıkış 250 - 315 Amper	1	12	150	10	49 x 100 x 66	315
LBE.1112.410	1 Giriş / 12 Çıkış 400 Amper	1	12	240	10	49 x 100 x 66	400
LBE.1212.315	2 Giriş / 12 Çıkış 250 - 315 Amper	2	12	95	10	49 x 100 x 66	315
LBE.1212.410	2 Giriş / 12 Çıkış 400 Amper	2	12	95	10	49 x 100 x 66	400

YENİ EK KLEMENSLERİ 315 - 800 AMPER

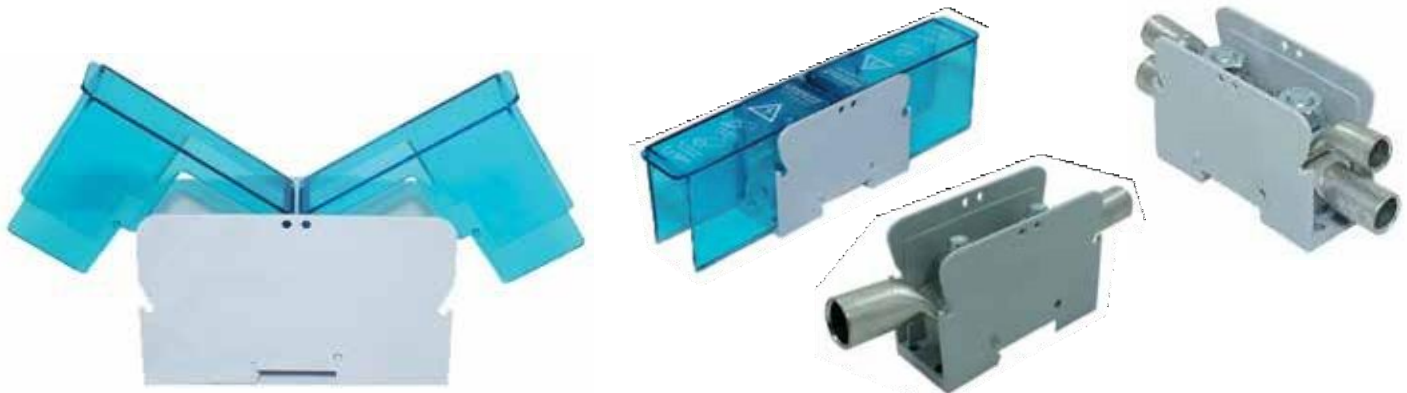

Sipariş Kodu	Açıklama	Giriş	Çıkış	Giriş Kablo Ø	Çıkış Kablo Ø	ExBxY (mm)	Akım I Max.
LBE.111.315	1 Giriş / 1 Çıkış Ek Klemensi	1	1	95	95	36 x 200 x 61	315
LBE.111.400	1 Giriş / 1 Çıkış Ek Klemensi	1	1	12	12	41 x 215 x 83	400
LBE.111.500	1 Giriş / 1 Çıkış Ek Klemensi	1	1	240	240	49 x 260 x 99	500
LBE.111.315	2 Giriş / 2 Çıkış Ek Klemensi	2	2	95	95	36 x 200 x 61	610
LBE.111.400	2 Giriş / 2 Çıkış Ek Klemensi	2	2	120	120	41 x 215 x 83	700
LBE.111.500	2 Giriş / 2 Çıkış Ek Klemensi	2	2	240	240	49 x 260 x 99	800

ZEMİNE VE RAYA MONTAJ EK SETLERİ



TEK KUTUP EK KLEMENSLERİ (1 GİRİŞ 1 ÇIKIŞ)

Sipariş Kodu	Açıklama	Amper	Giriş	Çıkış	Giriş Kablo Ø	Çıkış Kablo Ø	LxHxD (mm)	Paket Ad.
LB.111.305	1 x 50 - 95 EK	300	1	1	50 - 95	50 - 95	40 x 155 x 65	12
LB.111.405	1 x 70 - 120 EK	400	1	1	70 - 120	70 - 120	45 x 155 x 65	10
LB.111.605	1 x 120 - 240 EK	600	1	1	120 - 240	120 - 240	52 x 222 x 75	6



TEK KUTUP EK KLEMENSLERİ (2 GİRİŞ 2 ÇIKIŞ)

Sipariş Kodu	Açıklama	Amper	Giriş	Çıkış	Giriş Kablo Ø	Çıkış Kablo Ø	LxHxD (mm)	Paket Ad.
LB.122.600	2 x 50 - 95 EK	600	2	2	2 x 50 - 95	2 x 50 - 95	40 x 155 x 65	12
LB.122.755	2 x 70 - 120 EK	750	2	2	2 x 70 - 120	2 x 70 - 120	45 x 155 x 65	10
LB.122.805	2 x 120 - 240 EK	800	2	2	2 x 120 - 240	2 x 120 - 240	52 x 222 x 75	6
LB.122.605	4 x 25 - 50 EK	600	2	2	50	50	52 x 222 x 75	6



İKİ KUTUP EK KLEMENSLERİ (2 GİRİŞ 2 ÇIKIŞ)

Sipariş Kodu	Açıklama	Amper	Giriş	Çıkış	Giriş Kablo Ø	Çıkış Kablo Ø	LxHxD (mm)	Paket Ad.
LB.211.255	2 x (2x50) EK	250	2	2	50	50	52 x 222 x 75	6

EŞ POTANSİYEL BARALAR



25CMEŞ POTANSİYEL BARALAR

Sipariş Kodu	Açıklama	Giriş Kablo Ø	Çıkış Kablo Ø	Bakır Kesit (mm)	Uzunluk	Paket Ad.
LB.1108.250	1+8 ES250	1 x 35 - 150	8 x 16 - 95	30 x 3	250	1
LB.1108.400	1+8 ES400	1 x 35 - 150	8 x 16 - 95	30 x 5	250	1
LB.1108.500	1+8 ES500	1 x 35 - 150	8 x 16 - 95	2 x (30 x 3)	250	1
LB.1107.520	1+8 ES520	1 x 35 - 240	8 x 16 - 95	40 x 5	250	1
LB.1108.600	1+8 ES600	1 x 35 - 150	8 x 16 - 95	2 x (30 x 5)	250	1
LB.1108.750	1+8 ES750	1 x 35 - 240	8 x 16 - 95	40 x 10	250	1
LB.1108.CK	ŞEFFAF KAPAK				300	1



48CMEŞ POTANSİYEL BARALAR

Sipariş Kodu	Açıklama	Giriş Kablo Ø	Çıkış Kablo Ø	Bakır Kesit (mm)	Uzunluk	Paket Ad.
LB.1212.250	2+12 ES250	1 x 35 - 150	12 x 16 - 95	30 x 3	480	1
LB.1212.400	2+12 ES400	1 x 35 - 150	12 x 16 - 95	30 x 5	480	1
LB.1212.500	2+12 ES500	1 x 35 - 150	12 x 16 - 95	2 x (30 x 3)	480	1
LB.1210.520	2+12 ES520	1 x 35 - 240	12 x 16 - 95	40 x 5	480	1
LB.1212.600	2+12 ES600	1 x 35 - 150	12 x 16 - 95	2 x (30 x 5)	480	1
LB.1210.750	2+12 ES750	1 x 35 - 240	12 x 16 - 95	40 x 10	480	1
LB.1212.CK	ŞEFFAF KAPAK				500	1



70CMEŞ POTANSİYEL BARALAR

Sipariş Kodu	Açıklama	Giriş Kablo Ø	Çıkış Kablo Ø	Bakır Kesit (mm)	Uzunluk	Paket Ad.
LB.1221.250	2+21 ES250	1 x 35 - 150	21 x 16 - 95	30 x 3	700	1
LB.1221.400	2+21 ES400	1 x 35 - 150	21 x 16 - 95	30 x 5	700	1
LB.1221.500	2+21 ES500	1 x 35 - 150	21 x 16 - 95	2 x (30 x 3)	700	1
LB.1217.520	2+17 ES520	1 x 35 - 240	17 x 16 - 95	40 x 5	700	1
LB.1221.600	2+21 ES600	1 x 35 - 150	21 x 16 - 95	2 x (30 x 5)	700	1
LB.1217.750	2+17 ES750	1 x 35 - 240	17 x 16 - 95	40 x 10	700	1
LB.1217.CK	ŞEFFAF KAPAK				750	1

ÇİVATALI DAĞITICILAR (250 - 630 AMPER)

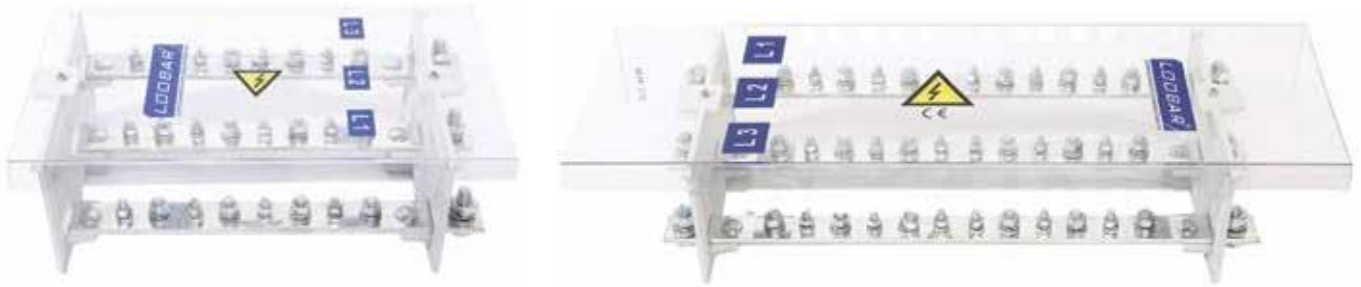

3 BARALI 250 AMPER

Sipariş Kodu	Açıklama	Amper	Giriş	Çıkış	Giriş Kablo Ø	Çıkış Kablo Ø	LxHxD (mm)	Paket Ad.
LB.3108.250	1+8 CU 3P250	250	1	8	50-150	6 - 95	330 x 200 x 100	1
LB.3212.250	2+12 CU 3P250	250	2	12	50-150	6 - 95	570 x200 x 100	1
LB.3220.250	2+21 CU 3P250	250	2	21	50-150	6 - 95	775 x 200 x 100	1

3 BARALI 400 AMPER

Sipariş Kodu	Açıklama	Amper	Giriş	Çıkış	Giriş Kablo Ø	Çıkış Kablo Ø	LxHxD (mm)	Paket Ad.
LB.3108.400	1+8 CU 3P400	400	1	8	50-150	6 - 95	330 x 200 x 100	1
LB.3212.400	2+12 CU 3P400	400	2	12	50-150	6 - 95	570 x200 x 100	1
LB.3220.400	2+21 CU 3P400	400	2	21	50-150	6 - 95	775 x 200 x 100	1

3 BARALI 630 AMPER

Sipariş Kodu	Açıklama	Amper	Giriş	Çıkış	Giriş Kablo Ø	Çıkış Kablo Ø	LxHxD (mm)	Paket Ad.
LB.3108.600	1+8 CU 3P630	630	1	8	50-150	6 - 95	330 x 200 x 100	1
LB.3212.600	2+12 CU 3P630	630	2	12	50-150	6 - 95	570 x200 x 100	1
LB.3220.600	2+21 CU 3P630	630	2	21	50-150	6 - 95	775 x 200 x 100	1



4 BARALI 250 AMPER

Sipariş Kodu	Açıklama	Amper	Giriş	Çıkış	Giriş Kablo Ø	Çıkış Kablo Ø	LxHxD (mm)	Paket Ad.
LB.4108.250	1+8 CU 4P250	250	1	8	50-150	6 - 95	330 x 200 x 100	1
LB.4212.250	2+12 CU 4P250	250	2	12	50-150	6 - 95	570 x200 x 100	1
LB.4220.250	2+21 CU 4P250	250	2	21	50-150	6 - 95	775 x 200 x 100	1

4 BARALI 400 AMPER

Sipariş Kodu	Açıklama	Amper	Giriş	Çıkış	Giriş Kablo Ø	Çıkış Kablo Ø	LxHxD (mm)	Paket Ad.
LB.4108.400	1+8 CU 4P400	400	1	8	50-150	6 - 95	330 x 200 x 100	1
LB.4212.400	2+12 CU 4P400	400	2	12	50-150	6 - 95	570 x200 x 100	1
LB.4220.400	2+21 CU 4P400	400	2	21	50-150	6 - 95	775 x 200 x 100	1

4 BARALI 630 AMPER

Sipariş Kodu	Açıklama	Amper	Giriş	Çıkış	Giriş Kablo Ø	Çıkış Kablo Ø	LxHxD (mm)	Paket Ad.
LB.4108.600	1+8 CU 4P630	630	1	8	50-150	6 - 95	330 x 200 x 100	1
LB.4212.600	2+12 CU 4P630	630	2	12	50-150	6 - 95	570 x200 x 100	1
LB.4220.600	2+21 CU 4P630	630	2	21	50-150	6 - 95	775 x 200 x 100	1

BAKIR DAĞITICILAR (400 - 630 AMPER)



3 BARALI 400 - 630 AMPER ZEMİNE MONTAJ

Sipariş Kodu	Açıklama	Amper	Giriş	Çıkış	Giriş Kablo Ø	Çıkış Kablo Ø	LxHxD (mm)	Paket Ad.
LB.3140.405	40 CU 3P400	400	1	6 - 25	50-150	1,5 - 95	330 x 230 x 110	1
LB.3140.605	40 CU 3P630	630	1	6 - 25	50-150	1,5 - 95	330x230x110	1
LB.3260.405	60 CU 3P400	400	2	10 - 40	50-150	1,5 - 95	570x230x110	1
LB.3260.605	60 CU 3P630	630	2	10 - 40	50-150	1,5 - 95	570x230x110	1
LB.3280.405	80 CU 3P400	400	2	15 - 50	50-150	1,5 - 95	775x230x110	1
LB.3280.605	80 CU 3P630	630	2	15 - 50	50-150	1,5 - 95	775x230x110	1



4 BARALI 400 - 630 AMPER ZEMİNE MONTAJ

Sipariş Kodu	Açıklama	Amper	Giriş	Çıkış	Giriş Kablo Ø	Çıkış Kablo Ø	LxHxD (mm)	Paket Ad.
LB.4140.405	40 CU 4P400	400	1	6 - 25	50-150	1,5 - 95	330x230x110	1
LB.4140.605	40 CU 4P630	630	1	6 - 25	50-150	1,5 - 95	330x230x110	1
LB.4260.405	60 CU 4P400	400	2	10 - 40	50-150	1,5 - 95	570x230x110	1
LB.4260.605	60 CU 4P630	630	2	10 - 40	50-150	1,5 - 95	570x230x110	1
LB.4280.405	80 CU 4P400	400	2	15 - 50	50-150	1,5 - 95	775x230x110	1
LB.4280.605	80 CU 4P630	630	2	15 - 50	50-150	1,5 - 95	775x230x110	1

ERICO - ERIFLEX FLEXIBAR

Sipariş Kodu	Açıklama	BAKIR KESİT mm ²	I AMP ΔT (K)=500C	I AMP ΔT (K)=400C	I AMP ΔT (K)=300C	Paket Ad.
EF.552390	2 x 15,5 5x0,8	24,8	212	191	165	10
EF.552490	2 x 20 x 1	40	275	246	214	5
EF.552500	3 x 20 x 1	60	360	323	280	5
EF.552520	5 x 20 x 1	100	420	346	326	5
EF.552530	6 x 20 x 1	120	462	413	358	5
EF.552550	2 x 24 x 1	48	380	340	295	5
EF.552570	4 x 24 x 1	96	465	416	360	5
EF.552580	5 x 24 x 1	120	514	460	398	5
EF.552590	6 x 24 x 1	144	566	506	438	5
EF.552650	5 x 32 x 1	160	640	573	496	5
EF.552660	6 x 32 x 1	192	715	640	555	5
EF.552670	8 x 32 x 1	256	860	770	667	5
EF.552720	5 x 40 x 1	200	760	680	590	5
EF.552730	6 x 40 x 1	240	860	770	667	5
EF.552740	6 x 40 x 1	320	1040	930	805	5
EF.552750	10 x 40 x 1	400	1181	1055	915	5
EF.552780	5 x 50 x 1	250	930	830	718	5
EF.552810	10 x 50 x 1	500	1395	1245	1080	2
EF.552870	10 x 63 x 1	630	1600	1435	1240	2
EF.552900	5 x 80 x 1	40	1175	1050	910	2
EF.552920	8 x 80 x 1	640	1600	1430	1240	2
EF.552930	10 x 80 x 1	800	1775	1585	1375	2
EF.552950	5 x 100 x 1	500	1385	1235	1070	2
EF.552980	10 x 100 x 1	1000	1985	1775	1535	2
EF.552990	12 x 100 x 1	1200	2115	1890	1636	2

ERIFLEX FLEXIBAR AKSESUARLARI

Sipariş Kodu	Açıklama	Maksimum mm	Paket Ad.
ER.553550	FS 24	24	25
ER.553560	FS 32	32	25
ER.553570	FS 40 - 63	63	10
ER.553580	FS 80 - 100	100	10
ER.553370	RFS 40 - 63	63	1
ER.553380	RFS 80 - 100	100	1
ER.553590	UFS KİT	100	1

ERICO 2 - 4 KUTUP DAĞITIM BARALARI



Sipariş Kodu	Açıklama	Amper	Giriş	Çıkış
ER.563720	2 P 2/15	40	2x16	15x4
ER.563900	2 P 1/3/3	80/100	1x25	3x4+3x6
ER.563910	2 P 2/6/7	80/100	2x25	6x4+7x6
ER.563800	2 P 1/1/5	100/125	1x35	1x25+5x6
ER.563810	2 P 1/3/11	100/125	1x35	3x25+11x6
ER.563740	4 P 2/11	40	2x16	11x4
ER.563920	4 P 1/3/3	80/100	1x25	3x4+3x6
ER.563930	4 P 2/4/5	80/100	2x25	4x4+5x6
ER.563940	4 P 2/6/7	80/100	2x25	6x4+7x6
ER.563820	4 P 1/1/5	100/125	1x35	1x25+5x6
ER.563830	4 P 1/3/7	100/125	1x35	3x25+7x6
ER.563840	4 P 3/1/11	100/125	3x35	1x25+11x6
ER.563200	4 P 1/3/7/1	160	1x50	3x35+7x16+1x6
ER.563990	4 P 1/3/8	160	1x50	3x35+8x16
ER.563995	4 P 1/1/2/4/7	250/400	1x120	1x50+2x35 / 4x25+7x16



ERICO 1 KUTUP DAĞITIM BARALARI

Sipariş Kodu	Açıklama	Amper	Giriş	Çıkış
ER.569010	1 P 2/15	80	3x6-16	4x6
ER.569020	1 P 1/7	125	1x10-35	7x16
ER.569030	1 P 1/7	160	1x10-70	7x16
ER.569040	1 P 1/11	250	1x35-120	2x35, 9x16
ER.569050	1 P 1/11	400	1x185	2x35, 9x16
ER.569051	1 P 2/12 CU	400	2x95	12x10
ER.569251	UD 400 212 AL	400	2x95	12x10
ER.569052	1 P 1/12 CU	400	1x185	12x10
ER.569252	UD 400 112 AL	400	1x185	12x10
ER.569041	1 P 1/6	250	Flexibar	6x16
ER.569060	1 P 1/11	500	Flexibar	2x35+9x16
ER.569160	Flexibar Konnektör	250		
ER.569170	Flexibar Konnektör	400		
ER.569200	UD 400 Jumper	400		



ERICO GUÇ KLEMENSLERİ

Sipariş Kodu	Açıklama	Amper	Giriş	Çıkış
ER.561160	SB80AL	80	1x16	1x16
ER.561161	SB125AL	125	1x10-35	1x10-35
ER.561162	SB160AL	160	1x10-70	1x10-70
ER.561163	SB250AL	250	1x35-120	1x35-120
ER.561164	SB400AL	400	1x95-240	1x95-240
ER.561165	SBF400AL	400	5x24x1	1x95-240
ER.561166	SB2C400AL	400	1x95-240	2x35-120
ER.561167	SBF2C400AL	400	5x24x1	2x35-120
ER.561168	SB630AL	630	1x240-500	1x240-500
ER.561169	SBF630AL	630	8x32x1	2x240-500
ER.561158	SB 125 10-35	160	1x10-35	1x10-35
ER.561159	SB 250 1x120	250	1x35-120	1x35-120
ER.561132	SBLL 250 16-400 M10	250	1x10-120	1x10-120
ER.561134	SBLL 500 16-400 M10	750	1x16-400	1x16-400
ER.561136	SBLL 800 2X(25-300mm2) M10	800	2x25-300	2x25-300
ER.561140	SBLT 250 1X(10-50)	250	1x10-120	2x10-50
ER.561141	SBTT 250 2x(10-50) GİRİŞ 2x(10-35)	250	2x10-50	2x10-50
ER.561142	SBLT 350 1x(10-185) GİRİŞ 1x(35-150)	350	1x10-185	1x35-185
ER.561143	SBTT 350 1x(35-185) GİRİŞ 1x(35-150)	350	1x35-185	1x35-185
ER.561144	SBLT 500 1x(95-400) GİRİŞ 2x(16-120)	500	1x95-400	2x16-120
ER.561145	SBTT 500 2x(16-120) GİRİŞ 2x(16-120)	500	2x16-120	2x16-120
ER.561146	SBLT 800 2x(95-240) GİRİŞ 2x(50-185)	800	2x35-300	2x95-240
ER.561147	SBTT 800 2x(95-240) GİRİŞ 2x(50-185)	800	2x95-240	2x95-240
ER.561154	1x95-240 GİRİŞ, 2x35-120	600	1x95-240	2x35-120
ER.561138	SBLC ZEMINE BAĞLANTI APARATI			



ERICO İZOLATÖRLER



Sipariş Kodu	Açıklama	Metrik	BOY mm	Paket Ad.
ER.548480	35 mm M8 2S	M8	35	25
ER.548580	50 mm M8 2S	M8	50	25
ER.548640	75 mm M12 2S	M12	75	10

Sipariş Kodu	Açıklama	Bara	Paket Ad.
ER.504991	Kare İzolatör	5-10	12
ER.560860	5 mm Bara Tutucu	5	1
ER.560870	4x5 mm Bara Tutucu	4x5	1
ER.560880	10 mm Bara Tutucu	10	1
ER.560890	2x10 mm Bara Tutucu	2x10	1
ER.560900	3x10 mm Bara Tutucu	3x10	1



ERICO BARA KLEMENSLERİ

Sipariş Kodu	Açıklama	Bara	Kablo	Paket Ad.
ER.553405	5 mm 1 - 4	5	1-4	15
ER.553400	5 mm 2,5 - 16	5	2,5-16	15
ER.553410	5 mm 16 - 50	5	16-50	15
ER.553510	5 mm 35 - 70	5	15-70	15
ER.553520	5 mm 70 - 185	5	70-185	15
ER.553505	10 mm 1-4	10	1-4	15
ER.553430	10 mm 2,5-16	10	2,5-16	15
ER.553440	10 mm 16 - 50	10	16-50	15
ER.553530	10 mm 35 - 70	10	15-70	15
ER.553540	10 mm 70 - 185	10	70-185	15



ERICO BARA KELEPÇELERİ

Sipariş Kodu	Açıklama	Boy	En	Paket Ad.
ER.553020	50x24x20 mm	50	24	3
ER.553030	50x32x20 mm	50	32	3
ER.553040	50x40x20 mm	50	40	3
ER.553050	80x24x20 mm	80	32	3
ER.553060	80x32x20 mm	80	24	3
ER.553070	80x50x20 mm	80	50	3
ER.568700	100x38x20 mm	100	38	3
ER.568730	120x32x20 mm	120	32	3



ERICO BARA KELEPÇELERİ

Sipariş Kodu	Açıklama	Metrik	Boy	Paket Ad.
ER.560660	15 mm	M5	15	100
ER.560670	20 mm	M5	20	100
ER.560600	30 mm	M5	30	100
ER.560840	M5 Vida	M5		100



RAYA MONTAJ KAPAKLI PANO PRİZİ (16 A / 250

Sipariş Kodu	Açıklama	Kutu / Koli
7160	Tek Girişli LED'siz Topraklı	10 / 120
7161	Çift Girişli LED'siz Topraklı	
7162	Tek Girişli LED'li Topraklı	
7163	Çift Girişli LED'li Topraklı	
7164	Tek Girişli LED'siz UPS'li	
7165	Çift Girişli LED'siz UPS'li	
7166	Tek Girişli LED'li USP'li	
7167	Çift Girişli LED'li USP'li	

t



Pano Termostatı, Ray Montaj



Sipariş Kodu	Açıklama
CTPT-100	0-60 °C, Isıtma için NK Kon.
CTPT-200	0-60 °C, Soğutma için NAK.
CTPT-300	0-60 °C, NK+NAKontak
CTPT-400	Higrostat %10 - %90Nem

Pano Isıtıcısı



Sipariş Kodu	Açıklama
CTPI-015	15 W
CTPI-025	25 W
CTPI-030	30 W
CTPI-050	50 W
CTPI-075	75 W
CTPI-100	100 W
CTPI-150	150 W
CTPI-100F	100 W Fanlı
CTPI-150F	150 W Fanlı
CTPI-250F	250 W Fanlı
CTPI-500F	500 W Fanlı
CTPI-750F	750 W Fanlı

PROJE CEPLERİ



Sipariş Kodu	Cinsi	Kutu Ad.
A5 TİPİ	Küçük - Yapışkan Bantlı	60
A4 TİPİ	Büyük - Yapışkan Bantlı	50

t



SAC KENAR FİTİLLERİ



CT-401	U-1 ince/Siyah-Kırmızı/Gri	100
CT-403	U-1 kalın/Siyah-Kırmızı/Gri	100

RACK KABİN FIRÇASI



CT-024	Kıl Kalınlığı 0.25-040 mm Kıl Boyu: 5 cm - 1 m	10	
CT-025	Kıl Kalınlığı 0.25-040 mm Kıl Boyu: 10 cm - 1 m	10	

PİRİNÇ KABLO RAKORU IP 68 (NİKEL KAPLI, SOMUNLU)

Sipariş Kodu	Diş Ölçüsü	Kablo Çapı (Min.-Max.) (mm)	Ambalaj (Ad.)
TPR-01	PG-7	3,0-6,5	50
TPR-02	PG-9	4,0-8,0	50
TPR-03	PG-11	5,0-10,0	50
TPR-04	PG-13.5	6,0-12,0	50
TPR-05	PG-16	10,0-14,0	25
TPR-06	PG-21	13,0-18,0	25
TPR-07	PG-29	18,0-25,0	20
TPR-08	PG-36	22,0-32,0	15
TPR-09	PG-42	30,0-38,0	12
TPR-10	PG-48	34,0-44,0	12
TMR-05	M12x1,5	3,0-6,5	50
TMR-01	M16x1,5	4,0-8,0	50
TMR-02	M20x1,5	6,0-12,0	50
TMR-03	M25x1,5	10,0-14,0	25
TMR-04	M32x1,5	13,0-18,0	25
TMR-05	M40x1,5	18,0-25,0	20
TMR-06	M50x1,5	22,0-32,0	15
TMR-07	M63x1,5	34,0-44,0	5
TMR-071	M63x1,5	37,0-53,0	5
TMR-08	M72x1,5	43,0-53,0	5
TMR-09	M75x2,0	56,0-62,0	1
TMR-10	M80x2,0	60,0-64,0	1
TNR-01	3/8	5,0 - 10,0	50
TNR-02	1/2	6,0-12,0	50
TNR-03	3/4	13,0-18,0	50
TNR-04	1	18,0-25,0	25
TNR-05	1 1/4	22,0-32,0	20

t

t



IP-68 PG POLYAMİD KABLO RAKORU

Sipariş Kodu	Boy	Montaj Çapı	Kutu Adedi	Koli Adedi
9000	PG-7	12.5	450	6750
9001	PG-9	15.5	300	4500
9002	PG-11	18.5	200	3000
9003	PG-13.5	20.5	175	2625
9004	PG-16	22.5	125	1875
9005	PG-21	28.5	75	1125
9006	PG-29	37.5	40	600
9007	PG-36	47.5	20	300
9008	PG-42	55.0	15	225
9009	PG-48	60.0	12	180

t

Renkler   
Ral: 7035 7001 9005



PG POLYAMİDSOMUN

Sipariş Kodu	Boy	Montaj Delik	Kutu Adedi
9070	PG-7	12.5	250
9071	PG-9	15.5	250
9072	PG-11	18.5	250
9073	PG-13.5	20.5	250
9074	PG-16	22.5	250
9075	PG-21	28.5	250
9076	PG-29	37.5	150
9077	PG-36	47.0	100
9078	PG-42	55.0	100
9079	PG-48	60.0	100

t

Renkler   
Ral: 7035 7001 9005



IP-68 METRİK POLYAMİD KABLO RAKORU

Sipariş Kodu	Boy	Montaj Çapı	Kutu Adedi	Koli Adedi
9050	M 12 x 1.5	12	450	6750
9051	M 16 x 1.5	16	200	3000
9052	M 20 x 1.5	20	150	2250
9053	M 25 x 1.5	25	75	1125
9054	M 32 x 1.5	32	40	600
9055	M 40 x 1.5	40	20	300

t



Renkler   
Ral: 7035 7001 9005



METRİK POLYAMİD SOMUN

Sipariş Kodu	Boy	Montaj Delik	Kutu Adedi
9010	M 12 x 1.5	12	250
9013	M 16 x 1.5	16	250
9016	M 20 x 1.5	20	250
9020	M 25 x 1.5	25	250
9023	M 32 x 1.5	32	250
9026	M 40 x 1.5	40	250

t

Renkler   
Ral: 7035 7001 9005



PG SPİRAL KABLO RAKORU

Sipariş Kodu	Boy	Montaj Çapı	Kutu Adedi
9275	PG 7	12	200
9281	PG 11	16	100
9284	PG 13.5	20	80
9290	PG 21	25	30
9276	PG 7	12	200
9282	PG 11	16	100
9285	PG 13.5	20	80
9291	PG 21	25	30
9277	PG 7	12	200
9283	PG 11	16	100
9286	PG 13.5	20	80
9292	PG 21	25	30

t



 Ral: 7001

 Ral: 7035

 Ral: 9005

METRİK SPİRAL KABLO RAKORU

Sipariş Kodu	Boy	Montaj Çapı	Kutu Adedi
9475	M 12 x 1.5	12	200
9478	M 16 x 1.5	16	100
9481	M 20 x 1.5	20	80
9484	M 25 x 1.5	25	30
9476	M 12 x 1.5	12	200
9479	M 16 x 1.5	16	100
9482	M 20 x 1.5	20	80
9485	M 25 x 1.5	25	30
9477	M 12 x 1.5	12	200
9480	M 16 x 1.5	16	100
9483	M 20 x 1.5	20	80
9486	M 25 x 1.5	25	30

t



 Ral: 7001

 Ral: 7035

 Ral: 9005

PG POLYAMİD KÖR TAPA

Sipariş Kodu	Boy	Montaj Delik	Kutu Adedi	Adet Fiyatı (₺)
9090	PG-7	12.5	250	
9091	PG-9	15.5	250	
9092	PG-11	18.5	250	
9093	PG-13.5	20.5	250	
9094	PG-16	22.5	250	
9095	PG-21	28.5	250	
9096	PG-29	37.5	150	
9097	PG-36	47.5	100	



 Ral: 7001

 Ral: 7035

 Ral: 9005

KÜÇÜK KÖR TAPA

Sipariş Kodu	Boy	Montaj Çapı	Kutu Adedi	Adet Fiyatı (₺)
9490	PG-13.5	17	100	
9491	PG-16	22.8	100	
9492	PG-21	28.6	100	
9493	PG-29	37.3	100	
9494	PG-36	47	100	
9495	PG-42	55	50	



KABLO MARKALAMACİHAZLARI



A. Cihaz ne işe yarar?

Özellikleri aşağıda belirtilen malzemelerin üzerlerine yazarak kabloların ve elektrik cihazlarının markalanmasında kullanılırlar. Çıplak ağırlıkları sadece 2 kg'dır.

B. Kaç çeşit printer cihazı modeli mevcut ve temel farklar nelerdir?

En son modeller olan M-1Std3, M-1Pro4 modelleri şu an stoklarımızda mevcuttur. Her 2 modelin çıktı kalitesi birebir aynıdır. (300dpi) M-1Pro modellerinin temel farkı, bir ara yüz vasıtasıyla PC'ye bağlanabilmesidir. M-1Pro modellerde artı olan diğer farklar ise; daha büyük bellek kapasitesi, daha hızlı yazma, extra malzeme tanıma sensörleri, daha fazla özel simge seçeneği, gelişmiş tuş takımı, daha büyük ve fonksiyonel LCD ekrandır.

C. Ne tür malzemelere yazar?

- 1) Pvc makaronlara (İç çap 2.5mm/6.5mm)
- 2) Isı ile daralan makaronlara (İç çap 2.0mm/7.7mm)
- 3) Şeffaf kablo kılıflarını markalamak için 4x0,5mm plastik şeritlere
- 4) Kendinden yapışkanlı PVC şerit etiketlere yazabilir. (En 6/9/12mm)
- 5) Kendinden yapışkanlı 0,5mm PVC şerit etiket plakalarına yazabilir. (En 8/9/10/11/12mm)

YAZICILAR

Sipariş Kodu	Ürün Tanımları
3230B 013AA	M-1 STD.3 Kablo markalama cihazı
3382B 014AA	M-1 PRO4 Kablo markalama cihazı

YAZICI KARBON ŞERİT KASETLER

Sipariş Kodu	Ürün Tanımları
3467B 001AA	Siyah (100m) IC Çipli
3467B 002AA	Beyaz (85m) IC Çipli
3476A 090AB	Beyaz (85m)
3476A 089AP	Siyah (100m) PVC etiketler için

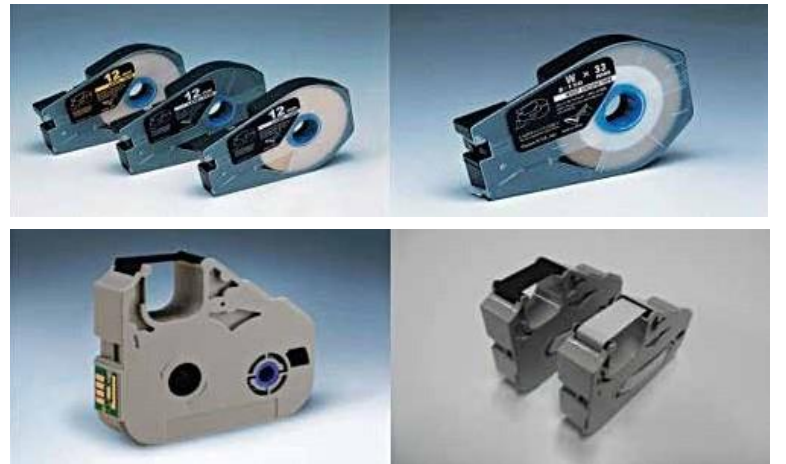

TEK DAMAR ÇOK TELLİ PVC İZOLELİ KABLONUN DIŞ ÇAP ÖLÇÜLERİ (mm) (Ölçüler firmaların resmi internet sitelerinden alınmıştır.)

	PEKTAŞ	NEXANS	HES	ALTIN	TÜMKA	ÖZNUR	PRYSMIAN
KESİTLER	0,75 mm ²	2,3	2,3	2,3	2,5	-	2,2
	1,00 mm ²	2,5	2,5	2,5	2,7	-	2,4
	1,50 mm ²	2,8	3	3	2,9	2,8	2,8
	2,50 mm ²	3,4	3,7	3,6	3,5	3,4	3,4
	4,00 mm ²	3,9	4,5	4,2	4,4	4,1	3,8
	6,00 mm ²	4,4	5,5	4,8	5,3	4,8	4,3
	10,00 mm ²	6,1	6,5	6,5	7,1	6	5,9
	16,00 mm ²	7,1	7,5	8	8,1	7,2	7



D. Yazma yöntemi ve kalitesi nedir?

Cihaz, karbon esaslı pigmenti, ısı ile yazılacak yüzeye dijital başlıkla transfer ederek seri ve yüksek kaliteli bir markalama yapar. Bu markalama yazısı normal hava şartlarına ve aşınmalara karşı dayanıklıdır. Aşırı ortam şartlarında da kullanılabilme uygulaması mevcuttur. Cihaz dijital olarak çalıştığından, diğer sıcak baskı yöntemleri gibi kalitenin sürekliliğinden insan faktörü etken değildir. Bu markalanan tüm yazıların aynı kalitede olmasını sürekli hale getirir. Belleği sayesinde çalışmalarınızı saklayıp, ihtiyaç halinde kullanımınıza sunarak extra fayda sağlar.

E. Kaç renk baskı yapabilir?

Karbon şerit kasetleri değiştirilerek siyah veya beyaz renk çıktı alınabilir.

FARKLI DİĞER TEKNİK ÖZELLİKLER:

	M-1Std.3	M-1Pro4
Yazma hızı (yavaş / orta / hızlı)	12,5-18,5-25mm/san	18,5-25-40mm/san
Bellek kapasitesi	2.500 karakter/dosya, Toplam 7.500 karakter	2.500 karakter/dosya, Toplam 15.000 karakter
Tuş takımı	Lastik tuş takımı	Notebook tipi tuş takımı
PC bağlantısı	—	Yazılım CD'si ve özel irtibat kablosu USB2.0

F. Yazılan malzemeler nasıl kullanılır?

- 1) Pvc makaronlar doğrudan kablo üzerine geçirilerek
- 2) Daralan makaronlar kablo üzerine geçirilip ısı ile daraltılarak,
- 3) 4x0,5mm plastik şeritler şeffaf kablo kılıfındaki yuvasına takılarak,
- 4) Kendinden yapışkanlı PVC şerit etiketler ise elektrik cihazlarının üzerlerine ve ihtiyaç duyulan tüm pürüzsüz yüzeyli yerlere yapıştırılarak,
- 5) Kendinden yapışkanlı PVC şerit plakalar ise elektrik pano kapak & cihazlarının üzerlerine ve ihtiyaç duyulan tüm pürüzsüz yüzeyli yerlerde kullanılır.

G. Yazılan malzemenin boy kesimi nasıl yapılır?

Cihazlar malzeme yazım işlemi sırasında otomatik olarak, kullanıcı tarafından seçilmiş kesim seçeneği doğrultusunda kesimi de gerçekleştirir.

H. Birim markalama kaç mal olur?

İç çapı 2,0mm ile 7,7mm arası daralan makaronlarda, 8 karakter, veya 2x8 karakter yazılmış birim parça maliyeti ortalama 0,01 ile 0,03 TL arasındadır. Muadil markalama yöntemlerine göre çok daha ucuz.

I. Cihaz ile birlikte neler veriliyor?

Birer adet; notebook tipi taşıma çantası, kullanım kılavuzu, siyah karbon şerit (DEMO) kaset, besleme adaptörü, makaron yazma adaptörü ve M-1pro'larda ayrıca yazıcı program CD'si ve özel irtibat kablosu (USB.2) verilmektedir.

PC BAĞLANTI ARAYÜZ SETİ

- Markalama cihazının kullanım kolaylığını artırır, görsellik zamandan tasarruf sağlar.
- Herhangi bir bilgisayar programında hazırlanmış yazdırılacak metinlerin, csv formatındaki text dosyasına ihraç (export) edildikten sonra CANON programıyla doğrudan açarak yazdırma işlemi gerçekleştirir. Bu bakımdan metin girişlerinin tek tek manuel olarak yapılma işi ortadan kalkmış olur.
- Cihazınızdaki tüm menü ve özellikleri bir arada gösterir. Bunların görsel ve pratik kullanım olanağını sunar.
- Yazdırılacak metinleri her pencerede max. 18'erli satırlar halinde görüntüler.

M-1Std.3 / M-1Pro4 ORTAK TEKNİK ÖZELLİKLER :

Makaron Çapları	PVC/daralan 2,5 - 6,5mm / 2,0 - 7,7mm
Şebeke Gerilimi	AC100-240V/ 50-60Hz (adaptör ile)
Çalışma Gerilimi	9V
Baskı Tekniği	Doğrudan ısısal baskı (Termal transfer)
Çözünürlük	300 dpi
Yazma Yönü	Yatay ve dikey
Satır Sayısı	3 satır veya SÜTUN / 2 satır veya SÜTUN
Harf yükseklikleri	1,3 / 2 - 3 - 6 mm
Harf Genişlikleri	Tam / Dar veya tam
Harf Aralıkları	Dar / orta / geniş
LCD kontrol ekranı	Grafik ekran (160x64 nokta)

YAPIŞKANLI PVC ŞERİT ETİKET KASETLERİ (30mt)

Sipariş Kodu	Ürün Tanımları
3476A 023AB	Beyaz 6mm
3476A 024AB	Beyaz 9mm
3476A 025AB	Beyaz 12mm
3476A 026AB	Sarı 6mm
3476A 027AB	Sarı 9mm
3476A 028AB	Sarı 12mm
3476A 068AA	Gümüş 6mm (27mt)
3476A 069AA	Gümüş 9mm (27mt)
3476A 070AA	Gümüş 12mm (27mt)

AKSESUARLAR

Sipariş Kodu	Ürün Tanımları
3471A 026AA	Makaron ısıtma ünitesi (Besleme adaptörü ile birlikte) (Soğuk ortam ve hava şartlarında kullanım içindir.)
3471A 027AA	Motorlu makaron sürme ünitesi (Besleme adaptörü ile birlikte)

Sipariş Kodu	Ürün Tanımları
Şeffaf kablo kılıfı plastik şerit kasetleri	
3476A 035AB	Beyaz / 4x0,5mm (5mt) plastik markalama şeridi
03780507001	Beyaz / 5mm en PVC yassı makaron & şerit (25mt)
Yapışkanlı koruyucu etiket kaset	
3476A 075AA	Beyaz 33 mm x 8 mt
Yedekleme malzemeleri	
3476A 042AB	Kesme ünitesi (Bıçak + karşılığı)
3476A 043AA	Temizleme ünitesi
3476A 044AA	Taşıyıcı çanta
3476A 046AA	Makaron yazdırma adaptörü (çap2mm-6,8mm)
3471A 033AD	7,7 mm Yassı makaron ve plaka yazdırma adaptörü
4F3-0494-000	Besleme adaptörü (Garanti kapsamı dışındadır.)

POLYAMİD PP SİRİAL BORULAR, RAKORLAR

POLYAMİD (PA6) SİRİAL BORU -40 °C, +120 °C

Sipariş Kodu	Renk	İç Çap (mm ²)	Dış Çap (mm ²)	Ambalaj (mt)
TPA-7	Gri - Siyah	6.5	10.0	100
TPA-8.5	Gri - Siyah	8.5	12.0	100
TPA-10	Gri - Siyah	10.0	13.0	100
TPA-12	Gri - Siyah	12.0	16.0	100
TPA-14	Gri - Siyah	14.0	18.5	50
TPA-17	Gri - Siyah	17.0	21.5	50
TPA-19	Gri - Siyah	19.0	24.0	50
TPA-22	Gri - Siyah	22.0	27.5	50
TPA-23	Gri - Siyah	23.0	28.7	50
TPA-26	Gri - Siyah	26.0	31.0	50
TPA-29	Gri - Siyah	29.0	34.5	25
TPA-36	Gri - Siyah	36.0	42.5	25
TPA-48	Gri - Siyah	48.0	54.5	25



POLİPROPİLEN PP SİRİAL BORU -20 °C, +90 °C

Sipariş Kodu	Renk	İç Çap (mm ²)	Dış Çap (mm ²)	Ambalaj (mt)
TPP-7	Gri - Siyah	6.5	10.0	100
TPP-8.5	Gri - Siyah	8.5	12.0	100
TPP-10	Gri - Siyah	10.0	13.0	100
TPP-12	Gri - Siyah	12.0	16.0	100
TPP-14	Gri - Siyah	14.0	18.5	100
TPP-17	Gri - Siyah	17.0	21.5	50
TPP-19	Gri - Siyah	19.0	24.0	50
TPP-22	Gri - Siyah	22.0	27.5	50
TPP-23	Gri - Siyah	23.0	28.7	50
TPP-26	Gri - Siyah	26.0	31.0	50
TPP-29	Gri - Siyah	29.0	34.5	25
TPP-36	Gri - Siyah	36.0	42.5	25
TPP-48	Gri - Siyah	48.0	54.5	25



GEÇMELİ PA6 SİRİAL RAKORU (PG DİŞ) IP68, SOMUNLU

Sipariş Kodu	Renk	Ölçü	Uygun Spiral	Ambalaj Ad.
WQG-P07/7	Gri - Siyah	PG-7	TPA-7	100
WQG-P09/10	Gri - Siyah	PG-9	TPA-10	100
WQG-P11/12	Gri - Siyah	PG-11	TPA-12	100
WQG-P13/14	Gri - Siyah	PG-13.5	TPA-14	100
WQG-P16/17	Gri - Siyah	PG-16	TPA-17	50
WQG-P21/23	Gri - Siyah	PG-21	TPA-23	50
WQG-P29/29	Gri - Siyah	PG-29	TPA-29	25
WQG-P36/36	Gri - Siyah	PG-36	TPA-36	20
WQG-P48/48	Gri - Siyah	PG-48	TPA-48	15





POLYAMİD PP SİRİAL BORULAR, RAKORLAR

POLYAMİD (PA6) YARIKLI SİRİAL BORU -40 °C, +120 °C

Tipi	Rakor Tipi	İç Çap (mm)	Dış Çap (mm)	Ambalaj Ad.
TPA-7 Y	Gri - Siyah	6,5	10	100
TPA-8,5 Y	Gri - Siyah	8,5	12	100
TPA-10 Y	Gri - Siyah	10	13	100
TPA-12 Y	Gri - Siyah	12	16	100
TPA-14 Y	Gri - Siyah	14	18,5	100
TPA-17 Y	Gri - Siyah	17	21,5	50
TPA-19 Y	Gri - Siyah	19	24	50
TPA-22 Y	Gri - Siyah	22	27,5	50
TPA-23 Y	Gri - Siyah	23	28,7	50
TPA-26 Y	Gri - Siyah	26	31	50
TPA-29 Y	Gri - Siyah	29	34,5	25
TPA-36 Y	Gri - Siyah	36	42,5	25
TPA-48 Y	Gri - Siyah	48	54,5	25



GEÇMELİ PA6 SİRİAL RAKORU (METRİK DİŞ) IP68, SOMUNLU

Sipariş Kodu	Renk	Ölçü	Uygun Spiral	Ambalaj Ad.
WQG-M12/7	Gri - Siyah	M12 x 1.5	TPA-7	100
WQG-M16/10	Gri - Siyah	M16 x 1.5	TPA-10	100
WQG-M16/12	Gri - Siyah	M16 x 1.5	TPA-12	100
WQG-M20/14	Gri - Siyah	M20 x 1.5	TPA-14	100
WQG-M20/17	Gri - Siyah	M20 x 1.5	TPA-17	50
WQG-M25/23	Gri - Siyah	M25 x 1.5	TPA-23	50
WQG-M32/29	Gri - Siyah	M32 x 1.5	TPA-29	25
WQG-M40/36	Gri - Siyah	M40 x 1.5	TPA-36	20
WQG-M50/48	Gri - Siyah	M50 x 1.5	TPA-48	20
WQG-M50/48/1 S	Gri - Siyah	M50 x 1.5	TPA-48	15
WQG-M63/48	Gri - Siyah	M63 x 1.5	TPA-48	15



GEÇMELİ PA6 SİRİAL 90° DİRSEK RAKORU IP68, SOMUNLU (SIZDIRMAZ)

Sipariş Kodu	Renk	Ölçü	Uygun Spiral	Ambalaj Ad.
WQW1-P07/7	Gri - Siyah	PG-7	TPA-7	50
WQW1-P09/10	Gri - Siyah	PG-9	TPA-10	50
WQW1-P11/12	Gri - Siyah	PG-11	TPA-12	50
WQW1-P13/14	Gri - Siyah	PG-13.5	TPA-14	25
WQW1-P16/17	Gri - Siyah	PG-16	TPA-17	25
WQW1-P21/23	Gri - Siyah	PG-21	TPA-23	25
WQW1-P29/29	Gri - Siyah	PG-29	TPA-29	25
WQW1-P36/36	Gri - Siyah	PG-36	TPA-36	10
WQW1-P48/48	Gri - Siyah	PG-48	TPA-48	10



POLYAMİD PP SİRAL BORULAR, RAKORLAR

POLYAMİD PA6 SİRAL KLİPSİ

Sipariş Kodu	Renk	Ölçü	Uygun Spiral	Ambalaj Ad.
TK-10	Gri - Siyah	PG-7	TPA-7	100
TK-12	Gri - Siyah	PG-8,5	TPA-8.5	100
TK-13	Gri - Siyah	PG-9	TPA-10	100
TK-16	Gri - Siyah	PG-11	TPA-12	100
TK-18	Gri - Siyah	PG-13.5	TPA-14	100
TK-21	Gri - Siyah	PG-16	TPA-17	50
TK-28	Gri - Siyah	PG-21	TPA-23	50
TK-34	Gri - Siyah	PG-29	TPA-29	25
TK-42	Gri - Siyah	PG-36	TPA-36	25
TK-54	Gri - Siyah	PG-48	TPA-48	10

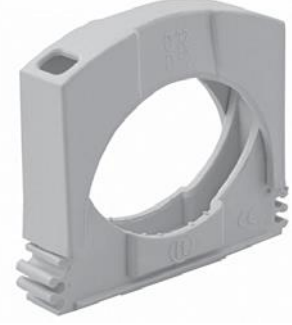

DİŞLİ PVC SİRAL BORU

Sipariş Kodu	Renk	İç Çap (mm ²)	Dış Çap (mm ²)	Ambalaj (mt)
TF-8	Açık Gri - Siyah	08.0	12.2	30
TF-10	Açık Gri - Siyah	10.0	14.7	30
TF-12	Açık Gri - Siyah	12.0	16.4	30
TF-14	Açık Gri - Siyah	14.0	18.9	30
TF-16	Açık Gri - Siyah	16.0	20.7	30
TF-20	Açık Gri - Siyah	20.0	24.7	30
TF-22	Açık Gri - Siyah	22.0	27.7	30
TF-25	Açık Gri - Siyah	25.0	30.6	30
TF-28	Açık Gri - Siyah	28.0	33.5	30
TF-35	Açık Gri - Siyah	35.0	41.0	30
TF-40	Açık Gri - Siyah	40.0	45.3	30
TF-50	Açık Gri - Siyah	50.0	56.0	30
TF-60	Açık Gri - Siyah	60.0	67.0	30



DİŞLİ SİRAL BORU RAKORU (SOMUNLU) IP65

Sipariş Kodu	Renk	Ölçü	Uygun Spiral	Ambalaj Ad.
TX-10/9	Açık Gri - Siyah	PG-9	TF-10	100
TX-12/11	Açık Gri - Siyah	PG-11	TF-12	100
TX-14/13	Açık Gri - Siyah	PG-13.5	TF-14	50
TX-16/16	Açık Gri - Siyah	PG-16	TF-16	50
TX-20/21	Açık Gri - Siyah	PG-21	TF-20	50
TX-28/29	Açık Gri - Siyah	PG-29	TF-29	50



SİRAL KELEPÇESİ (P KLİPSİ)

Tipi	Ölçü	Uygun Spiral	Paket Miktarı
PK -10	PG-7	EF/TN-7	100
PK -13	PG-9	EF/TN-10	100
PK -16	PG-11	EF/TN-12	100
PK -18	PG-13,5	EF/TN-16/17	100
PK - 20	PG-16	EF/TN-16/18	100
PK - 25	PG-21	EF/TN-21	50
PK - 32	PG-29	EF/TN-27	50
PK - 40	PG-36	EF/TN-35	25
PK - 50	PG-42	EF/TN-40	25
PK - 65	PG-48	EF/TN-50	25





VT SERİSİ T DAĞITICI

Tipi	Sip. Kodu Gri	Sip. Kodu Siyah	Spiral Ölçüsü	Paket Mik.
VT 080808	GRİ RENK İMALATI YOKTUR	83702410	06/06/06	10
VT 120808		83702412	09/06/06	10
VT 120812		83702414	09/06/09	10
VT 121208		83702416	09/09/06	10
VT 121212		83702418	09/09/09	10
VT 160816		83702420	11/06/11	10
VT 161212		83702422	11/09/09	10
VT 161216		83702424	11/09/11	10
VT 161612		83702426	11/11/09	10
VT 161616		83702426	11/11/11	10
VT 200820		83702428	16/06/16	10
VT 201216		83702432	16/09/11	10
VT 201220		83702434	16/09/16	10
VT 201616		83702436	16/11/11	10
VT 201620		83702438	16/11/16	10
VT 202016		83702440	16/16/11	10
VT 202020		83702441	16/16/16	10
VT 281220		83702442	21/09/16	10
VT 281620		83702444	21/11/16	10
VT 282020		83702446	21/16/16	10
VT 281228		83702448	21/09/21	10
VT 281628		83702450	21/11/21	10
VT 282028		83702452	21/16/21	10
VT 282828		83702454	21/21/21	10
VT 321632		83702456	29/11/29	10
VT 322032		83702458	29/16/29	10



Y DAĞITICI

Tipi	Sip. Kodu Gri	Sip. Kodu Siyah	Spiral Ölçüsü	Paket Mik.
SVY 080808	GRİ RENK İMALATI YOKTUR	83701410	06/06/06	10
SVY 120808		83701412	09/06/06	10
SVY 121208		83701414	09/09/06	10
SVY 121212		83701416	09/09/09	10
SVY 161208		83701418	11/09/06	10
SVY 161212		83701420	11/09/09	10
SVY 161608		83701422	11/11/06	10
SVY 161612		83701424	11/11/09	10
SVY 200808		83701426	16/06/06	10
SVY 201208		83701428	16/09/06	10
SVY 201212		83701430	16/09/09	10
SVY 201608		83701432	16/11/06	10
SVY 201612		83701434	16/11/09	10
SVY 202008		83701436	16/16/06	10
SVY 202012		83701438	16/16/09	10
SVY 202016		83701440	16/16/11	10
SVY 282012		83701442	21/16/09	10
SVY 282016		83701444	21/16/11	10
SVY 282812		83701446	21/21/09	10
SVY 282816		83701448	21/21/11	10
SVY 282820		83701450	21/21/16	10



SİNYAL LAMBALARI



Sipariş Kodu	Renk	Cinsi	K. / AD.	
Ø 22 mm Led'li Sinyal				
WL22-71-24	○	Beyaz Renk Sinyal Lambası 24V DC	10	
WL22-73-24	●	Yeşil Renk Sinyal Lambası 24V DC	10	
WL22-74-24	●	Kırmızı Renk Sinyal Lambası 24V DC	10	
WL22-75-24	●	Sarı Renk Sinyal Lambası 24V DC	10	
WL22-76-24	●	Mavi Renk Sinyal Lambası 24V DC	10	
WL22-71	○	Beyaz Renk Sinyal Lambası 250V AC	10	
WL22-73	●	Yeşil Renk Sinyal Lambası 250V AC	10	
WL22-74	●	Kırmızı Renk Sinyal Lambası 250V AC	10	
WL22-75	●	Sarı Renk Sinyal Lambası 250V AC	10	
WL22-76	●	Mavi Renk Sinyal Lambası 250V AC	10	

Ø 16 mm Led'li Sinyal				
WL-16-73	●	Ø 16 mm Led 220 V. AC	20	
WL-16-74	●	Ø 16 mm Led 220 V. AC	20	
WL-16-75	●	Ø 16 mm Led 220 V. AC	20	

Ø 16 mm Led'li Sinyal				
WL-16-73-24	●	Ø 16 mm Led 12/24 V. AC-DC	20	
WL-16-74-24	●	Ø 16 mm Led 12/24 V. AC-DC	20	
WL-16-75-24	●	Ø 16 mm Led 12/24 V. AC-DC	20	

Ø 22 mm Led'li Buzzer - Sesli Buzzer (90 dB)				
LED 22-220 LED+Buzzer	● + 📢	Ø 22 Led + Buzzer 220-240 V. AC	10	
LED 22-24 LED+Buzzer	● + 📢	Ø 22 Led + Buzzer 12/24 V. AC-DC	10	
LED 22-220 Buzzer	📢	Ø 22 Led + Buzzer 220-240 V. AC	10	
LED 22-24 Buzzer	📢	Ø 22 Led + Buzzer 12/24 V. AC-DC	10	

BA9S Led Ampul				
BA9SL-220W	○	BA9S 220-240 V. AC Led Ampul	50	
BA9SL-220G	●	BA9S 220-240 V. AC Led Ampul	50	
BA9SL-220R	●	BA9S 220-240 V. AC Led Ampul	50	
BA9SL-220Y	●	BA9S 220-240 V. AC Led Ampul	50	
BA9SL-220B	●	BA9S 220-240 V. AC Led Ampul	50	
BA9SL-110W	○	BA9S 110-130 V AC/DC Led Ampul	50	
BA9SL-110G	●	BA9S 110-130 V AC/DC Led Ampul	50	
BA9SL-110R	●	BA9S 110-130 V AC/DC Led Ampul	50	
BA9SL-110Y	●	BA9S 110-130 V AC/DC Led Ampul	50	
BA9SL-110B	●	BA9S 110-130 V AC/DC Led Ampul	50	
BA9SL-24W	○	BA9S 24-30 V AC/DC Led Ampul	50	
BA9SL-24G	●	BA9S 24-30 V AC/DC Led Ampul	50	
BA9SL-24R	●	BA9S 24-30 V AC/DC Led Ampul	50	
BA9SL-24Y	●	BA9S 24-30 V AC/DC Led Ampul	50	
BA9SL-24B	●	BA9S 24-30 V AC/DC Led Ampul	50	

WL9 SERİSİ



YENİ PLASTİK YAYLI BUTONLAR

KOD	ÖZELLİK	RENK	ADET
WL9-AA11	Ø22 mm Plastik Yaylı Buton - Start Buton (1NO)	○	10
WL9-AA21	Ø22 mm Plastik Yaylı Buton - Start Buton (1NO)	●	10
WL9-AA31	Ø22 mm Plastik Yaylı Buton - Start Buton (1NO)	●	10
WL9-AA51	Ø22 mm Plastik Yaylı Buton - Start Buton (1NO)	●	10
WL9-AA61	Ø22 mm Plastik Yaylı Buton - Start Buton (1NO)	●	10
WL9-AA42	Ø22 mm Plastik Yaylı Buton - Stop Buton (1NC)	●	10



PLASTİK İŞARETLİ YAYLI BUTONLAR

KOD	ÖZELLİK	RENK	ADET
WL9-AA3341	Ø22 mm Plastik Yaylı Buton - Start Buton (1NO) (Ok Yönleri İstenildiğinde Değiştirilebilir)	⬆	10
WL9-AA3351	Ø22 mm Plastik Yaylı Buton - Stop Buton (1NO) (Ok Yönleri İstenildiğinde Değiştirilebilir)	⬆	10
WL9-AA3361	Ø22 mm Plastik Yaylı Buton - Start Buton (1NO)	⬆	10
WL9-AA4322	Ø22 mm Plastik Yaylı Buton - Start Buton (1NC)	⊘	10
WL9-AA3371	Ø22 mm Plastik Yaylı Buton - Start Buton (1NO)	⚠	10
WL9-AA3381	Ø22 mm Plastik Yaylı Buton - Start Buton (1NO)	⚠	10



PLASTİK İKİZ BUTONLAR

KOD	ÖZELLİK	RENK	ADET
WL9-AL7325	Ø22 mm Plastik İkiz Buton (1NO/1NC)	■	10
WL9-AW7465L	Ø22 mm Plastik İkiz Buton (1NO/1NC) Ledli 220VAC	■	10
WL9-AW7465-24L	Ø22 mm Plastik İkiz Buton (1NO/1NC) Ledli 24VAC/DC	■	10
WL9-AL7425	Ø22 mm Plastik İşaretlİ İkiz Buton (1NO/1NC)	■	10
WL9-AL7525	Ø22 mm Plastik Yazılı İkiz Buton (1NO/1NC)	■	10
WL9-AL4151	Ø22 mm Plastik Yukarı - Aşağı Oklu İkiz Buton (1NO/1NO)	■	10
WL9-AL4252	Ø22 mm Pls.Yukarı - Aşağı Oklu Ters Yönlü İkiz Buton (1NO/1NO)	■	10
WL9-AL6171	Ø22 mm Plastik Alarm - Ortak Oklu İkiz Buton (1NO/1NO)	■	10
WL9-AL7181	Ø22 mm Plastik Alarm - Lamba İkiz Buton (1NO/1NO)	■	10
WL9-AL6181	Ø22 mm Plastik Lamba - Ortak Oklu İkiz Buton (1NO/1NO)	■	10

WL9 SERİSİ

AD21-KALICI



AD33-KALICI



AD41-KAYICI



AD53-KAYICI

PLASTİK KALICI ve KAYICI MANDAL BUTONLAR

KOD	ÖZELLİK	ADET
WL9-AD21	0-1 (∩) Plastik Kalıcı Mandal Buton (1NO) - 3 Kontak Takılabilir	10
WL9-AD33	1-0-2 (∩∩) Plastik Kalıcı Mandal Buton (1NO+1NO) - 3 Kontak Takılabilir	10
WL9-AD41	0-1 (∩) Plastik Kayıcı Mandal Buton (1NO) - 3 Kontak Takılabilir	10
WL9-AD53	1-0-2 (∩∩) Plastik Kayıcı Mandal Buton (1NO+1NO) - 3 Kontak Takılabilir	10

AS542



AS542E



AS142



AS442



AS542NO

PLASTİK MANTAR ACİL STOP BUTONLAR

KOD	ÖZELLİK	RENK	ADET
WL9-AS542	Ø40 mm Kafa Plastik Mantar Buton (1NC) Acil Stop	●	10
WL9-AS542E	Ø40 mm Kafa Plastik Mantar Buton (1NC) Acil Stop - Etiketli	●	10
WL9-AS142	Ø40 mm Kafa Plastik Anahtarlı Mantar Buton (1NC) Acil Stop	●	10
WL9-AS442	Ø30 mm Kafa Plastik Mantar Buton (1NC) Acil Stop	●	10
WL9-AS542NO	Ø40 mm Kafak Plastik Mantar Buton (1NO) Acil Stop	●	10

AC31



AC51



AC42

PLASTİK KAYICI MANTAR BUTONLAR

KOD	ÖZELLİK	RENK	ADET
WL9-AC31	Ø22 mm Plastik Kayıcı Mantar Buton (1NO)	●	10
WL9-AC51	Ø22 mm Plastik Kayıcı Mantar Buton (1NO)	●	10
WL9-AC42	Ø22 mm Plastik Kayıcı Mantar Buton (1NC)	●	10

3 KONTAK YANYANA

WL9 SERİSİ

YENİ PLASTİK LEDLİ İŞKİLİYAYLI BUTONLAR

KOD	ÖZELLİK	RENK	ADET	
WL9-AW3375	Ø22 mm Plastik Ledli Yaylı Buton (1NO) - 110-240VAC	●	10	
WL9-AW3575	Ø22 mm Plastik Ledli Yaylı Buton (1NO) - 110-240VAC	●	10	
WL9-AW3675	Ø22 mm Plastik Ledli Yaylı Buton (1NO) - 110-240VAC	●	10	
WL9-AW3475	Ø22 mm Plastik Ledli Yaylı Buton (1NC) - 110-240VAC	●	10	
WL9-AW3375-24	Ø22 mm Plastik Ledli Yaylı Buton (1NO) - 10-30VAC-DC	●	10	
WL9-AW3575-24	Ø22 mm Plastik Ledli Yaylı Buton (1NO) - 10-30VAC-DC	●	10	
WL9-AW3675-24	Ø22 mm Plastik Ledli Yaylı Buton (1NO) - 10-30VAC-DC	●	10	
WL9-AW3475-24	Ø22 mm Plastik Ledli Yaylı Buton (1NC) - 10-30VAC-DC	●	10	

0-1 PLASTİK LEDLİ KALICI MANDAL BUTONLAR

KOD	VÖZELLİK	RENK	ADET	
WL9-AK123L	0-1 () Plastik Ledli Kalıcı Mandal Buton (1NO) 110-240VAC	●	10	
WL9-AK124L	0-1 () Plastik Ledli Kalıcı Mandal Buton (1NC) 110-240VAC	●	10	
WL9-AK125L	0-1 () Plastik Ledli Kalıcı Mandal Buton (1NO) 110-240VAC	●	10	
WL9-AK123-24L	0-1 () Plastik Ledli Kalıcı Mandal Buton (1NO) 10-30VAC-DC	●	10	
WL9-AK124-24L	0-1 () Plastik Ledli Kalıcı Mandal Buton (1NC) 10-30VAC-DC	●	10	
WL9-AK125-24L	0-1 () Plastik Ledli Kalıcı Mandal Buton (1NO) 10-30VAC-DC	●	10	

1-0-2 PLASTİK LEDLİ KALICI MANDAL BUTONLAR

KOD	ÖZELLİK	RENK	ADET	
WL9-AK323L	1-0-2 () Plastik Ledli Kalıcı Mandal Buton (1NO) 110-240VAC	●	10	
WL9-AK324L	1-0-2 () Plastik Ledli Kalıcı Mandal Buton (1NC) 110-240VAC	●	10	
WL9-AK325L	V1-0-2 () Plastik Ledli Kalıcı Mandal Buton (1NO) 110-240VAC	●	10	
WL9-AK323-24L	1-0-2 () Plastik Ledli Kalıcı Mandal Buton (1NO) 10-30VAC-DC	●	10	
WL9-AK324-24L	1-0-2 () Plastik Ledli Kalıcı Mandal Buton (1NC) 10-30VAC-DC	●	10	
WL9-AK325-24L	1-0-2 () Plastik Ledli Kalıcı Mandal Buton (1NO) 10-30VAC-DC	●	10	

WL9 SERİSİ

AG21-KALICI



AG33-KALICI



AG41-KAYICI



AG53-KAYICI

PLASTİK ANAHTARLI KALICI ve KAYICI BUTONLAR

KOD	ÖZELLİK	ADET
WL9-AG21	0-1 (I) Plastik Kalıcı Anahtarlı Buton (1NO) - 3 Kontak Takılabilir	10
WL9-AG33	1-0-2 (II) Plastik Kalıcı Anahtarlı Buton (1NO+1NO) - 3 Kontak Takılabilir	10
WL9-AG41	0-1 (II) Plastik Kayıcı Anahtarlı Buton (1NO) - 3 Kontak Takılabilir	10
WL9-AG53	1-0-2 (III) Plastik Kayıcı Anahtarlı Buton (1NO+1NO) - 3 Kontak Takılabilir	10

BE101





BE102



BE103-PARMAKLED

YEDEK KONTAK BLOKLARI

KOD	ÖZELLİK	RENK	ADET
WL9-BE101	Kontak Bloğu (1NO)		100
WL9-BE102	Kontak Bloğu (1NC)		100

3 KONTAK YANYANA
Ø22 POTANSİYOMETRE

WL9 SERİSİ

BA11



BA21



BA31



BA51



BA61



BA42

YENİ METAL KAPLAMALI YAYLI BUTONLAR

KOD	ÖZELLİK	RENK	ADET
WL9-BA11	Ø22 mm Yaylı Buton - Start Buton (1NO)	○	10
WL9-BA21	Ø22 mm Yaylı Buton - Start Buton (1NO)	●	10
WL9-BA31	Ø22 mm Yaylı Buton - Start Buton (1NO)	●	10
WL9-BA51	Ø22 mm Yaylı Buton - Start Buton (1NO)	●	10
WL9-BA61	Ø22 mm Yaylı Buton - Start Buton (1NO)	●	10
WL9-BA42	Ø22 mm Yaylı Buton - Stop Buton (1NC)	●	10

BA3341



BA3351



BA3361



BA4322



BA3371



BA3381

METAL KAPLAMALI İŞARETLİ YAYLI BUTONLAR

KOD	ÖZELLİK	RENK	ADET
WL9-BA3341	Ø22 mm İşaretli Yaylı Buton - Start Buton (1NO) (Ok Yönleri İstenildiğinde Değiştirilebilir)	①	10
WL9-BA3351	Ø22 mm İşaretli Yaylı Buton - Stop Buton (1NO) (Ok Yönleri İstenildiğinde Değiştirilebilir)	⓫	10
WL9-BA3361	Ø22 mm İşaretli Yaylı Buton - Start Buton (1NO)	⓫	10
WL9-BA4322	Ø22 mm İşaretli Yaylı Buton - Start Buton (1NC)	⓫	10
WL9-BA3371	Ø22 mm İşaretli Yaylı Buton - Start Buton (1NO)	⓫	10
WL9-BA3381	Ø22 mm İşaretli Yaylı Buton - Start Buton (1NO)	⓫	10

BL7325



BL7425



BL7525



BL6171



BL7181



BL4151



BL4252



BL6181

METAL KAPLAMALI İKİZ BUTONLAR

KOD	ÖZELLİK	RENK	ADET
WL9-BL7325	Ø22 mm İkiz Buton (1NO/1NC)	■	10
WL9-BW7465L	Ø22 mm İkiz Buton (1NO/1NC) Ledli 220VAC	■	10
WL9-BW7465-24L	Ø22 mm İkiz Buton (1NO/1NC) Ledli 24VAC/DC	■	10
WL9-BL7425	Ø22 mm Metal İşaretli İkiz Buton (1NO/1NC)	■	10
WL9-BL7525	Ø22 mm Metal Yazılı İkiz Buton (1NO/1NC)	■	10
WL9-BL4151	Ø22 mm Metal Yukarı - Aşağı Oklu İkiz Buton (1NO/1NO)	⓫	10
WL9-BL4252	Ø22 mm Pls.Yukarı - Aşağı Oklu Ters Yönlü İkiz Buton (1NO/1NO)	⓫	10
WL9-BL6171	Ø22 mm Metal Alarm - Ortak Oklu İkiz Buton (1NO/1NO)	⓫	10
WL9-BL7181	Ø22 mm Metal Alarm - Lamba İkiz Buton (1NO/1NO)	⓫	10
WL9-BL6181	Ø22 mm Metal Lamba - Ortak Oklu İkiz Buton (1NO/1NO)	⓫	10

WL9 SERİSİ



METAL KAPLAMALI KALICI ve KAYICI MANDAL BUTONLAR

KOD	ÖZELLİK	ADET
WL9-BD21	0-1 (⌋) Kalıcı Mandal Buton (1NO) - 3 KONTAK TAKILABİLİR	10
WL9-BD33	1-0-2 (⌋) Kalıcı Mandal Buton (1NO+1NO) - 3 KONTAK TAKILABİLİR	10
WL9-BD41	0-1 (⌋) Kayıcı Mandal Buton (1NO) - 3 KONTAK TAKILABİLİR	10
WL9-BD53	1-0-2 (⌋) Kayıcı Mandal Buton (1NO+1NO) - 3 KONTAK TAKILABİLİR	10



PLASTİK MANTAR ACİL STOP BUTONLAR

KOD	ÖZELLİK	RENK	ADET
WL9-AS542	Ø40 mm Kafa Plastik Mantar Buton (1NC) Acil Stop	●	10
WL9-AS542E	Ø40 mm Kafa Plastik Mantar Buton (1NC) Acil Stop - Etiketli	●	10
WL9-AS142	Ø40 mm Kafa Plastik Anahtarlı Mantar Buton (1NC) Acil Stop	●	10
WL9-AS442	Ø30 mm Kafa Plastik Mantar Buton (1NC) Acil Stop	●	10
WL9-AS542NO	Ø40 mm Kafak Plastik Mantar Buton (INO) Acil Stop	●	10



PLASTİK KAYICI MANTAR BUTONLAR

KOD	ÖZELLİK	RENK	ADET
WL9-AC31	Ø22 mm Plastik Kayıcı Mantar Buton (1NO)	●	10
WL9-AC51	Ø22 mm Plastik Kayıcı Mantar Buton (1NO)	●	10
WL9-AC42	Ø22 mm Plastik Kayıcı Mantar Buton (1NC)	●	10

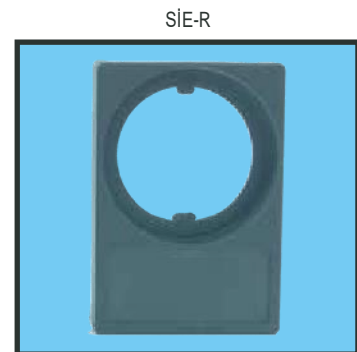
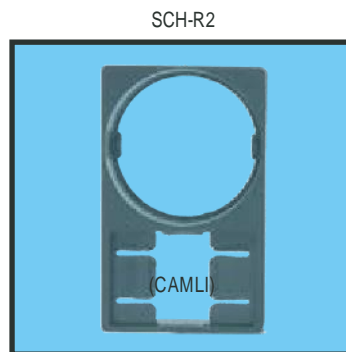
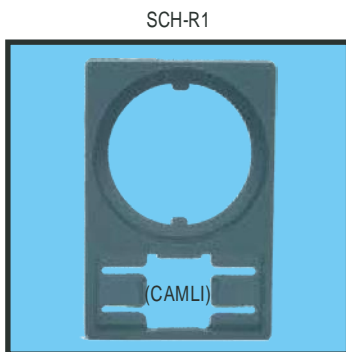

WL9 SERİSİ

YENİ METAL KAPLAMALI LEDLİ İŞIKLI YAYLI BUTONLAR

KOD	ÖZELLİK	RENK	ADET
WL9-BW3375	Ø22 mm Ledli Yaylı Buton (1NO) - 110-240VAC	●	10
WL9-BW3575	Ø22 mm Ledli Yaylı Buton (1NO) - 110-240VAC	●	10
WL9-BW3675	Ø22 mm Ledli Yaylı Buton (1NO) - 110-240VAC	●	10
WL9-BW3475	Ø22 mm Ledli Yaylı Buton (1NC) - 110-240VAC	●	10
WL9-BW3375-24	Ø22 mm Ledli Yaylı Buton (1NO) - 10-30VAC-DC	●	10
WL9-BW3575-24	Ø22 mm Ledli Yaylı Buton (1NO) - 10-30VAC-DC	●	10
WL9-BW3675-24	Ø22 mm Ledli Yaylı Buton (1NO) - 10-30VAC-DC	●	10
WL9-BW3475-24	Ø22 mm Ledli Yaylı Buton (1NC) - 10-30VAC-DC	●	10

0-1 METAL KAPLAMALI LEDLİ KALICI MANDAL BUTONLAR

KOD	VÖZELLİK	RENK	ADET
WL9-BK123L	0-1 (∩) Ledli Kalıcı Mandal Buton (1NO) 110-240VAC	●	10
WL9-BK124L	0-1 (∩) Ledli Kalıcı Mandal Buton (1NC) 110-240VAC	●	10
WL9-BK125L	0-1 (∩) Ledli Kalıcı Mandal Buton (1NO) 110-240VAC	●	10
WL9-BK123-24L	0-1 (∩) Ledli Kalıcı Mandal Buton (1NO) 10-30VAC-DC	●	10
WL9-BK124-24L	0-1 (∩) Ledli Kalıcı Mandal Buton (1NC) 10-30VAC-DC	●	10
WL9-BK125-24L	0-1 (∩) Ledli Kalıcı Mandal Buton (1NO) 10-30VAC-DC	●	10

1-0-2 METAL KAPLAMALI LEDLİ KALICI MANDAL BUTONLAR

KOD	ÖZELLİK	RENK	ADET
WL9-BK323L	1-0-2 (∩∩) Ledli Kalıcı Mandal Buton (1NO) 110-240VAC	●	10
WL9-BK324L	1-0-2 (∩∩) Ledli Kalıcı Mandal Buton (1NC) 110-240VAC	●	10
WL9-BK325L	V1-0-2 (∩∩) Ledli Kalıcı Mandal Buton (1NO) 110-240VAC	●	10
WL9-BK323-24L	1-0-2 (∩∩) Ledli Kalıcı Mandal Buton (1NO) 10-30VAC-DC	●	10
WL9-BK324-24L	1-0-2 (∩∩) Ledli Kalıcı Mandal Buton (1NC) 10-30VAC-DC	●	10
WL9-BK325-24L	1-0-2 (∩∩) Ledli Kalıcı Mandal Buton (1NO) 10-30VAC-DC	●	10

WL9 SERİSİ

AG21-KALICI



AG33-KALICI



AG41-KAYICI



AG53-KAYICI

PLASTİK ANAHTARLIKALICI ve KAYICI BUTONLAR

KOD	ÖZELLİK	ADET
WL9-AG21	0-1 (⌚) Plastik Kalıcı Anahtarlı Buton (1NO) - 3 KONTAK TAKILABİLİR	10
WL9-AG33	1-0-2 (⌚) Plastik Kalıcı Anahtarlı Buton (1NO+1NO) - 3 KONTAK TAKILABİLİR	10
WL9-AG41	0-1 (⌚) Plastik Kayıcı Anahtarlı Buton (1NO) - 3 KONTAK TAKILABİLİR	10
WL9-AG53	1-0-2 (⌚) Plastik Kayıcı Anahtarlı Buton (1NO+1NO) - 3 KONTAK TAKILABİLİR	10

BE101





BE102



BE103-PARMAK LED

YEDEK KONTAK BLOKLARI

KOD	ÖZELLİK	RENK	ADET
WL9-BE101	Kontak Bloğu (1NO)		100
WL9-BE102	Kontak Bloğu (1NC)		100

3 KONTAK YANYANA

WL5 SERİSİ



PLASTİK YAYLI BUTONLAR

KOD	ÖZELLİK	RENK	ADET
WL5-AA11	Ø22 mm Plastik Yaylı Buton - Start Buton (1NO)	○	10
WL5-AA21	Ø22 mm Plastik Yaylı Buton - Start Buton (1NO)	●	10
WL5-AA31	Ø22 mm Plastik Yaylı Buton - Start Buton (1NO)	●	10
WL5-AA51	Ø22 mm Plastik Yaylı Buton - Start Buton (1NO)	●	10
WL5-AA61	Ø22 mm Plastik Yaylı Buton - Start Buton (1NO)	●	10
WL5-AA42	Ø22 mm Plastik Yaylı Buton - Stop Buton (1NC)	●	10



PLASTİK İŞARETLİ YAYLI BUTONLAR

KOD	ÖZELLİK	RENK	ADET
WL5-AA3311	Ø22 mm Plastik Yaylı Buton - Start Buton (1NO)	○	10
WL5-AA4322	Ø22 mm Plastik Yaylı Buton - Stop Buton (1NC)	●	10
WL5-AA3341	Ø22 mm Plastik Yaylı Buton - Start Buton (1NO) (Ok Yönleri İstenildiğinde Değiştirilebilir)	○	10
WL5-AA3351	Ø22 mm Plastik Yaylı Buton - Start Buton (1NO) (Ok Yönleri İstenildiğinde Değiştirilebilir)	●	10
WL5-AA5111	Ø22 mm Plastik Yaylı Buton - Start Buton (1NO)	●	10
WL5-AA3361	Ø22 mm Plastik Yaylı Buton - Start Buton (1NO)	●	10



PLASTİK İKİZ BUTONLAR

KOD	ÖZELLİK	RENK	ADET
WL5-AL7325	Ø22 mm Plastik İkiz Buton (1NO/1NC)	■	10
WL5-AW7465L	Ø22 mm Plastik İkiz Buton (1NO/1NC) Ledli 220VAC	■	10
WL5-AW7465-24L	Ø22 mm Plastik İkiz Buton (1NO/1NC) Ledli 24VAC/DC	■	10



PLASTİK MANTAR ACİL STOP

KOD	ÖZELLİK	ADET
WL5-AS542	Ø22 mm Plastik Mantar Buton (1NC) - Acil Stop	10
WL5-AS542NO	Ø22 mm Plastik Mantar Buton (1NO) - Acil Stop	10

WL5 SERİSİ
CE

AC42



AC31



AC21

PLASTİK MANTAR KAYICI BUTONLAR

KOD	ÖZELLİK	RENK	ADET
WL5-AC42	Ø22 mm Plastik Mantar Buton (1NC) - Mantar Kayıcı	●	10
WL5-AC31	Ø22 mm Plastik Mantar Buton (1NO) - Mantar Kayıcı	●	10
WL5-AC21	Ø22 mm Plastik Mantar Buton (1NO) - Mantar Kayıcı	●	10

AD21



AD33



AD41



AD53

PLASTİK KALICI VE KAYICIMANDAL BUTONLAR

KOD	ÖZELLİK	ADET
WL5-AD21	0-1 (∩) Plastik Kalıcı Mandal Buton (1NO) - 3 Kontak Takılabilir	10
WL5-AD33	1-0-2 (∩∩) Plastik Kalıcı Mandal Buton (1NO+1NO)	10
WL5-AD41	0-1 (∩) Plastik Kayıcı Mandal Buton (1NO)	10
WL5-AD53	1-0-2 (∩∩) Plastik Kayıcı Mandal Buton (1NO+1NO)	10

AG21



AG33

PLASTİK KALICI ANAHTARLI BUTONLAR

KOD	ÖZELLİK	ADET
WL5-AG21	0-1 (∩) Plastik Kalıcı Anahtarlı Buton (1NO) - 3 Kontak Takılabilir	10
WL5-AG33	1-0-2 (∩∩) Plastik Kalıcı Anahtarlı Buton (1NO+1NO)	10

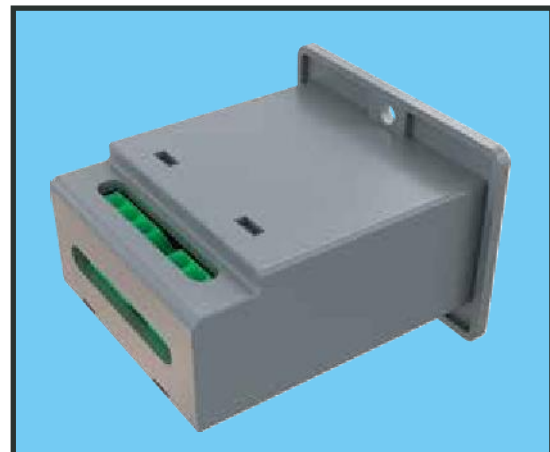
MADE IN TURKEY

WL5 SERİSİ

AW3175



AW3375



AW3475



AW3575



AW3675

PLASTİK LEDLİ İŞIKLI YAYLI BUTONLAR

KOD	ÖZELLİK	RENK	ADET
WL5-AW3175	Ø22 mm Plastik Ledli Yaylı Buton (1NO) - 110-240VAC	⊖	10
WL5-AW3375	Ø22 mm Plastik Ledli Yaylı Buton (1NO) - 110-240VAC	●	10
WL5-AW3475	Ø22 mm Plastik Ledli Yaylı Buton (1NC) - 110-240VAC	●	10
WL5-AW3575	Ø22 mm Plastik Ledli Yaylı Buton (1NC) - 110-240VAC	●	10
WL5-AW3675	Ø22 mm Plastik Ledli Yaylı Buton (1NC) - 110-240VAC	●	10
WL5-AW3175-24	Ø22 mm Plastik Ledli Yaylı Buton (1NO) - 10-30VAC-DC	⊖	10
WL5-AW3375-24	Ø22 mm Plastik Ledli Yaylı Buton (1NO) - 10-30VAC-DC	●	10
WL5-AW3475-24	Ø22 mm Plastik Ledli Yaylı Buton (1NC) - 10-30VAC-DC	●	10
WL5-AW3575-24	Ø22 mm Plastik Ledli Yaylı Buton (1NO) - 10-30VAC-DC	●	10
WL5-AW3675-24	Ø22 mm Plastik Ledli Yaylı Buton (1NO) - 10-30VAC-DC	●	10

AK123L



AK124L



AK323L



AK324L

PLASTİK LEDLİ İŞIKLI KALICI MANDAL BUTONLAR

KOD	ÖZELLİK	RENK	ADET
WL5-AK-123L	Ø22 mm 0-1 Kalıcı Ledli Mandal Buton (1NO) 240VAC	●	10
WL5-AK-124L	Ø22 mm 0-1 Kalıcı Ledli Mandal Buton (1NC) 240VAC	●	10
WL5-AK-123L-24	Ø22 mm 0-1 Kalıcı Ledli Mandal Buton (1NO) 24VAC-DC	●	10
WL5-AK-124L-24	Ø22 mm 0-1 Kalıcı Ledli Mandal Buton (1NC) 24VAC-DC	●	10
WL5-AK-323L	Ø22 mm 1-0-2 Kalıcı Ledli Mandal Buton (1NO+1NO) 240VAC	●	10
WL5-AK-324L	Ø22 mm 1-0-2 Kalıcı Ledli Mandal Buton (1NC+1NC) 240VAC	●	10
WL5-AK-323L-24	Ø22 mm 1-0-2 Kalıcı Ledli Mandal Buton (1NO+1NO) 24VAC-DC	●	10
WL5-AK-324L-24	Ø22 mm 1-0-2 Kalıcı Ledli Mandal Buton (1NC+1NC) 24VAC-DC	●	10

BE101



PARMAK LED



BE102

YEDEK KONTAK BLOK

KOD	ÖZELLİK	RENK	ADET
WL5-BE101	Start Kontak (1NO)		50
WL5-BE102	Stop Kontak (1NO)		50
WL5-.....P.LED	Parmak Led Kontak Bloğu (. 'lı Bölüm İçin Renk ve Voltaj Belirtiliniz.)		10

Ø22 mm PLASTİK ve METAL KAPLAMALI POTANSİYOMETRE TEK TUR

KOD	ÖZELLİK	ADET
WL9-PT1K	Ø22 mm Plastik Potansiyometre (1K)	10
WL9-PT2K	Ø22 mm Plastik Potansiyometre (2K)	10
WL9-PT5K	Ø22 mm Plastik Potansiyometre (5K)	10
WL9-PT10K	Ø22 mm Plastik Potansiyometre (10K)	10
WL9-PT1K-M	Ø22 mm Plastik Potansiyometre (1K)	10
WL9-PT2K-M	Ø22 mm Plastik Potansiyometre (2K)	10
WL9-PT5K-M	Ø22 mm Metal Kaplamalı Potansiyometre (5K)	10
WL9-PT10K-M	Ø22 mm Metal Kaplamalı Potansiyometre (10K)	10



Ø22 mm PLASTİK ve METAL KAPLAMALI POTANSİYOMETRE TEK TUR

KOD	ÖZELLİK	ADET
WL5-PT1K	Ø22 mm Plastik Potansiyometre (1K)	10
WL5-PT2K	Ø22 mm Plastik Potansiyometre (2K)	10
WL5-PT5K	Ø22 mm Plastik Potansiyometre (5K)	10
WL5-PT10K	Ø22 mm Plastik Potansiyometre (10K)	10
WL5-PT1K-M	Ø22 mm Plastik Potansiyometre (1K)	10
WL5-PT2K-M	Ø22 mm Plastik Potansiyometre (2K)	10
WL5-PT5K-M	Ø22 mm Metal Kaplamalı Potansiyometre (5K)	10
WL5-PT10K-M	Ø22 mm Metal Kaplamalı Potansiyometre (10K)	10

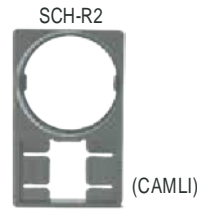
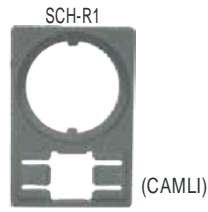

BUTON AKSESUARLARI

KOD	ÖZELLİK	ADET
WL5-BR1	Plastik Buton Rozeti (26 x 8 mm Camlı)	100
WL5-BR2	Plastik Buton Rozeti (26 x 18 mm Camlı)	100
WL5-SCH-R1	Plastik Buton Rozeti (27 x 12 mm Camlı)	80
WL5-SCH-R2	Plastik Buton Rozeti (27 x 18 mm Camlı)	80
WL5-SİE-R	Plastik Buton Rozeti (27 x 12 mm Camsız)	80
WL5-KTS (PG16)	Ø22 mm Plastik Somunlu Kör Tapa (Renk Belirtiniz - Gri / Siyah)	100
WL5-KTG (PG16)	Ø22 mm Plastik Geçmeli Tip Kör Tapa (Renk Belirtiniz - Gri / Siyah)	100

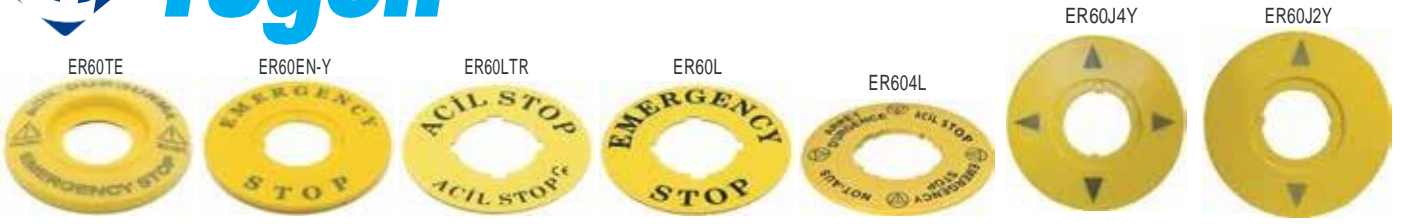

ACIL STOP ETİKETLERİ

KOD	ÖZELLİK	ADET
WL5-ER60L	Ø60 mm Leksan Baskılı Emergency Yapışkanlı Etiket	50
WL5-ER60LTR	Ø60 mm Leksan Baskılı Acil Stop Yapışkanlı Etiket	50
WL5-ER60TE	Ø60 mm Plastik Acil Durdurma + Emergency Rozeti (Kalın Tip) LAZER BASKI	50
WL5-ER60EN	Ø60 mm Plastik Emergency Rozeti (Kalın Tip) LAZER BASKI	50
WL5-ER60TE-Y	Ø60 mm Plastik Acil Durdurma + Emergency Rozeti - (İnce Tip) LAZER BASKI	50
WL5-ER60EN-Y	Ø60 mm Plastik Emergency Rozeti - (İnce Tip) LAZER BASKI	50
WL5-ER60TR-Y	Ø60 mm Plastik Acil Stop Rozeti - (İnce Tip) LAZER BASKI	50
WL5-ER60J2Y	Ø60 mm Plastik İki Yönlü Joystick Rozeti - (İnce Tip) LAZER BASKI	50
WL5-ER60J4Y	Ø60 mm Plastik Dört Yönlü Joystick Rozeti - (İnce Tip) LAZER BASKI	50
WL5-ER604L	Ø60 mm Plastik Dört Dilde Acil Stop Rozeti - (İnce Tip) LAZER BASKI	50



YAYLI BUTON KORUMA KILIF ve KAPAKLARI

KOD	ÖZELLİK	RENK	ADET
WL5-AP2	IP67 Buton Koruma Kılıfı (Yaylı Butonlar İçin)	ŞEFFAF	100
WL5-AP4	IP67 İkiz Buton Koruma Kılıfı (Yaylı Butonlar İçin) WL9 Serisi İkiz Butonların Kılıfıdır	ŞEFFAF	50
WL5-ASP	Acil Stop Koruma Kapağı (Tam Kapaklı Mühürü Tip)		10
WL5-AKKM	Acil Stop Koruma Kapağı		20
WL5-AKK	Acil Stop Koruma Kapağı		20
WL5-AKKY	Acil Stop Koruma Kapağı - YENİ-		20
WL5-ASKK	Acil Stop Koruma Kapağı (Yarım Ay Şeklinde)		20
WL5-MKK	Mandal Buton Koruma Kapağı		20
WL5-MKKY	Mandal Buton Koruma Kapağı - YENİ-		20



BOŞ KUMANDA KUTULARI

KOD	ÖZELLİK	RENK	ADET	FİYAT (TL)
LAY5-BX01S	1'li Boş Kumanda Kutusu (Sarı - Siyah)		1	5,50
LAY5-BX01SK	1'li Boş Kumanda Kutusu Korumalı (Sarı Siyah)		1	6,00
WL9-BX01S	1'li Boş Kumanda Kutusu (Sarı Siyah)		1	6,00
WL5-DA101	1'li Boş Alüminyum Buton Kutusu		1	90,00
WL5-DAK101	1'li Boş Alüminyum Korumalı Buton Kutusu		1	105,00



KUTULU MONTAJLI ÜRÜNLER

KOD	ÖZELLİK	RENK	ADET	FİYAT (TL)
WL9-KK31	1'li Kutulu Start Butonu (1NO)	Yeşil	3	21,00
WL9-KK42	1'li Kutulu Stop Butonu (1NC)	Qırmızı	3	21,00
WL9-KK51	1'li Kutulu Start Butonu (1NO)	Sarı	3	21,00
WL9-BX71	1'li Kutulu Alarm Butonu (1NO)	Sarı	3	22,50
WL9-BX81	1'li Kutulu Aydınlatma Butonu (1NO)	Sarı	3	22,50
WL9-BX542	1'li Kutulu Acil Stop Butonu (1NC)	Sarı	3	25,00
WL9-BX542KAS	1'li Kutulu Plastik Korunmalı Acil Stop Butonu (1NC) - Yeni Tip	Sarı	3	29,00
LAYS-BX542KES	1'li Kutulu Plastik Korunmalı Acil Stop Butonu (1NC) - Eski Tip	Sarı	3	22,00
WL9-BX542KASP	1'li Kutulu Plastik Korunmalı Pencereli Bas-Çek Acil Stop Butonu (1NC)	Sarı	3	78,00
WL9-BX21	1'li Kutulu Plastik Korunmalı Revizyon Butonu	Sarı	3	25,00
WL9-KANT	1'li Kutulu Kayıcı Reset Anahtarı	Sarı	3	45,00
WL9-KBZ	1'li Kutulu Kabin Altı İkaz Lambası - Buzzerlı	Sarı	3	33,00
WL9-KK7325	1'li Kutulu İkiz Buton (1NO+1NC)	Sarı	3	42,00
WL9-BX542ASP	1'li Kutulu Mühürlü Tip Korunmalı Acil Stop Butonu (1NC)	Sarı	3	54,00
WL9-BYP3K	1'li Kutulu 3 Kademe By-Pass Anahtarı	Sarı	3	86,00
WL5-DAK542E	1'li Kutulu Alüminyum Korunmalı Etiketli Acil Stop Butonu (1NC)	Sarı	3	285,00



KUTULU AÇ-KAPA PAKO ŞALTERLER (SİPARİŞLERİNİZDE KAFA MODELİNİ BELİRTİNİZ.)



KOD	ÖZELLİK	ADET	FİYAT (TL)
WL9-PK01110	0-1 / 10A Aç-Kapa Kutulu Pako Şalter	3	41,80
WL9-PK01116	0-1 / 16A Aç-Kapa Kutulu Pako Şalter	3	48,50
WL9-PK01125	0-1 / 25A Aç-Kapa Kutulu Pako Şalter	3	63,50
WL9-PK01310	0-1 / 3x10A Aç-Kapa Kutulu Pako Şalter	3	61,00
WL9-PK01316	0-1 / 3x16A Aç-Kapa Kutulu Pako Şalter	3	71,50
WL9-PK01325	0-1 / 3x25A Aç-Kapa Kutulu Pako Şalter	3	92,50

KUTULU KUTUP DEĞİŞTİRİCİ PAKO ŞALTERLER (SİPARİŞLERİNİZDE KAFA MODELİNİ BELİRTİNİZ.)

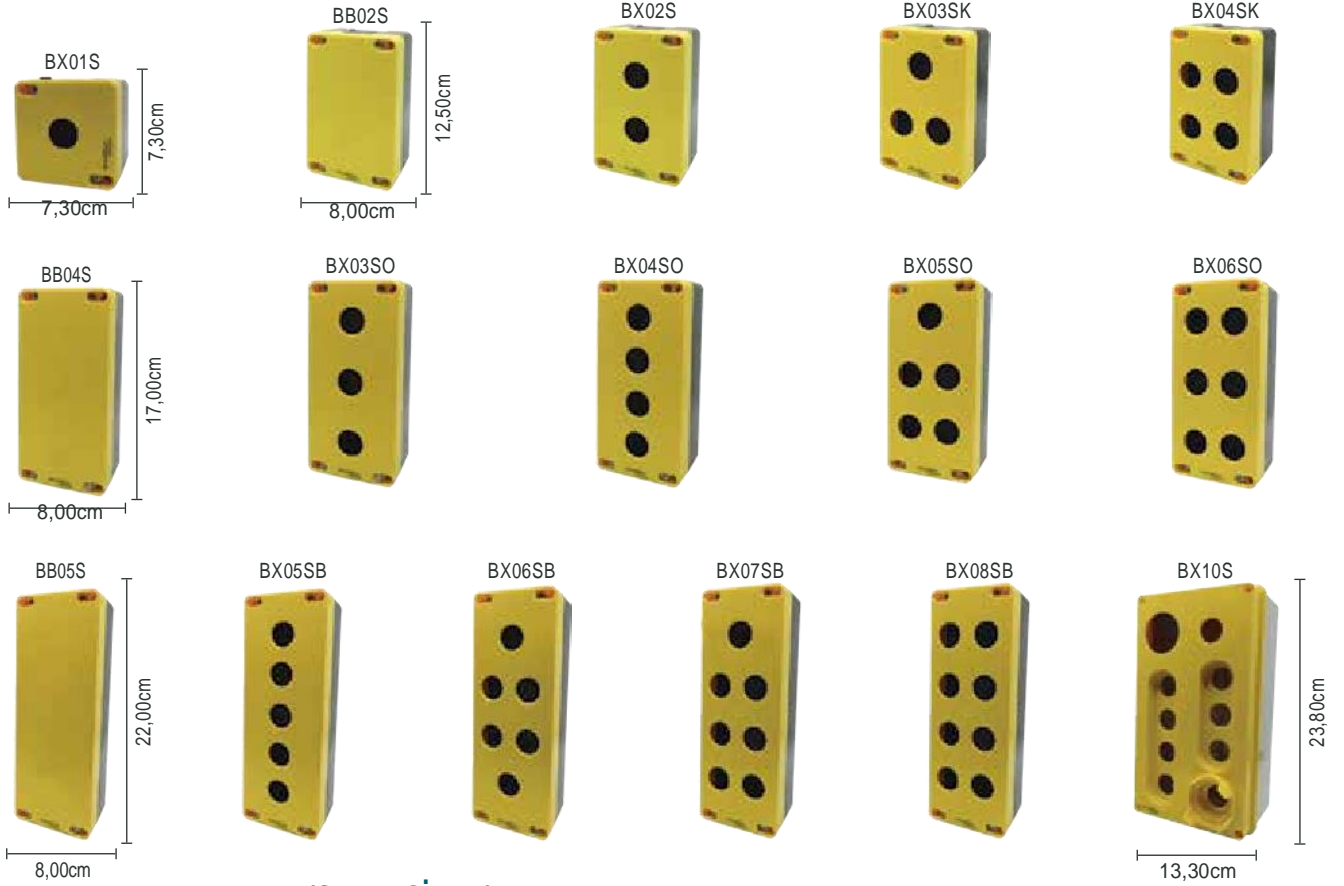
KOD	ÖZELLİK	ADET	FİYAT (TL)
WL9-PK102110	1-0-2 / 10A Kutup Değiştirici Kutulu Pako Şalter	3	55,00
WL9-PK102116	1-0-2 / 16A Kutup Değiştirici Kutulu Pako Şalter	3	57,50
WL9-PK102125	1-0-2 / 25A Kutup Değiştirici Kutulu Pako Şalter	3	81,00
WL9-PK102310	1-0-2 / 3x10A Kutup Değiştirici Kutulu Pako Şalter	3	86,50
WL9-PK102316	1-0-2 / 3x16A Kutup Değiştirici Kutulu Pako Şalter	3	96,50
WL9-PK102325	1-0-2 / 3x25A Kutup Değiştirici Kutulu Pako Şalter	3	144,00



BOŞ KUMANDA KUTULARI (SARI - SİYAH)

KOD	ÖZELLİK	ÖLÇÜ (cm)	RENK	ADET	
WL9-BX01S	1'li Sarı - Siyah Boş Kutu	7,3x7,3x6,5		1	
WL9-BX02S	2'li Sarı - Siyah Boş Kutu	8x12,5x5,7		1	
WL9-BX03SK	3'lü Sarı - Siyah Küçük Boy Boş Kutu	8x12,5x5,7		1	
WL9-BX04SK	4'lü Sarı - Siyah Küçük Boy Boş Kutu	8x12,5x5,7		1	
WL9-BX03SO	3'lü Sarı - Siyah v Boy Boş Kutu	8x17x5,7		1	
WL9-BX04SO	4'lü Sarı - Siyah Orta Boy Boş Kutu	8x17x5,7		1	
WL9-BX05SO	5'li Sarı - Siyah Orta Boy Boş Kutu	8x17x5,7		1	
WL9-BX06SO	6'lı Sarı - Siyah Orta Boy Boş Kutu	8x17x5,7		1	
WL9-BX05SB	5'li Sarı - Siyah Büyük Boy Boş Kutu	8x22x5,7		1	
WL9-BX06SB	6'lı Sarı - Siyah Büyük Boy Boş Kutu	8x22x5,7		1	
WL9-BX07SB	7'li Sarı - Siyah Büyük Boy Boş Kutu	8x22x5,7		1	
WL9-BX08SB	8'li Sarı - Siyah Büyük Boy Boş Kutu	8x22x5,7		1	
WL9-BX09SB	9'lu Sarı - Siyah Büyük Boy Boş Kutu	-		1	
WL9-BX10S	10'lu Sarı - Siyah Boş Kutu	-		1	
WL9-BB02S	2'li Sarı - Siyah Deliksiz Küçük Boy Boş Kutu	8x12,5x5,7		1	8,00
WL9-BB04S	4'lü Sarı - Siyah Deliksiz Orta Boy Boş Kutu	8x17x5,7		1	13,00
WL9-BB05S	5'li Sarı - Siyah Deliksiz Büyük Boy Boş Kutu	8x22x5,7		1	



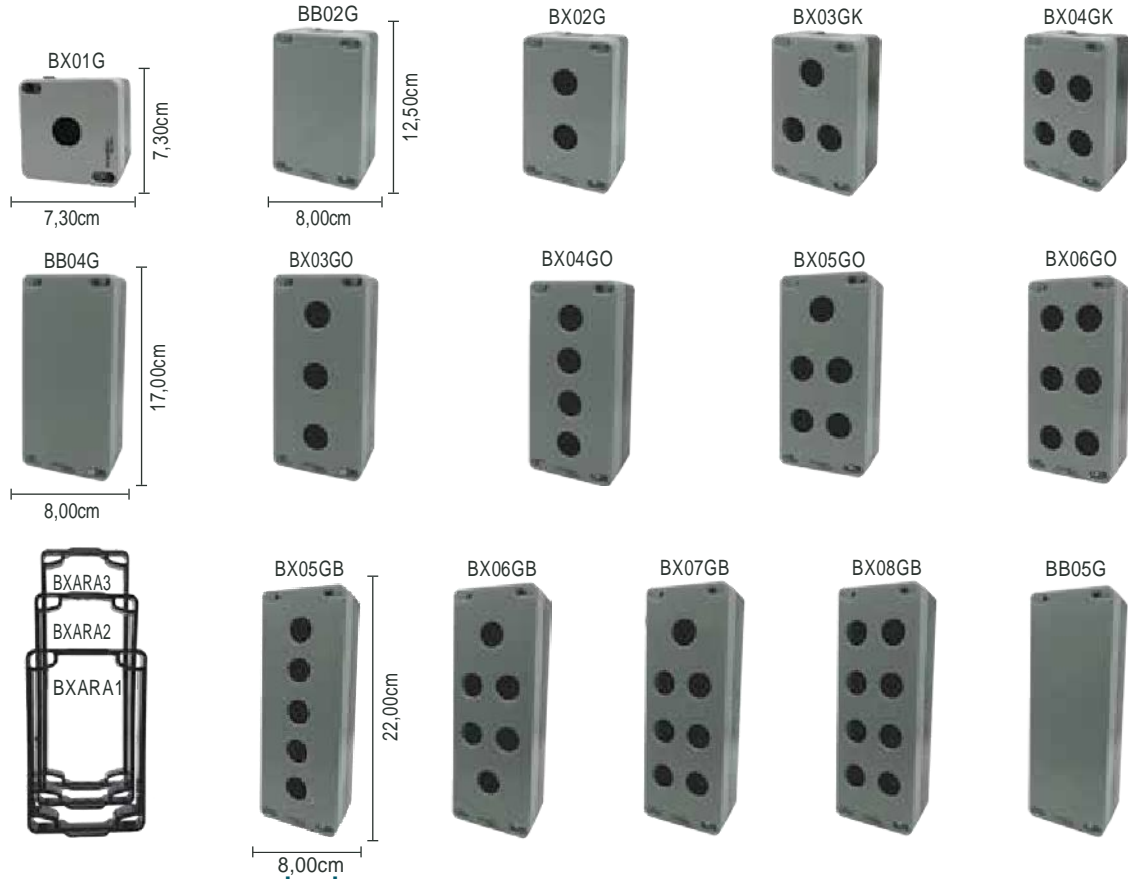

BOŞ KUMANDA KUTULARI (GRİ - SİYAH)

KOD	ÖZELLİK	ÖLÇÜ (cm)	RENK	ADET
WL9-BX01G	1'li Gri - Siyah Boş Kutu	7,3x7,3x6,5		1
WL9-BX02G	2'li Gri - Siyah Boş Kutu	8x12,5x5,7		1
WL9-BX03GK	3'lü Gri - Siyah Küçük Boy Boş Kutu	8x12,5x5,7		1
WL9-BX04GK	4'lü Gri - Siyah Küçük Boy Boş Kutu	8x12,5x5,7		1
WL9-BX03GO	3'lü Gri - Siyah Orta Boy Boş Kutu	8x17x5,7		1
WL9-BX04GO	4'lü Gri - Siyah Orta Boy Boş Kutu	8x17x5,7		1
WL9-BX05GO	5'li Gri - Siyah Orta Boy Boş Kutu	8x17x5,7		1
WL9-BX06GO	6'li Gri - Siyah Orta Boy Boş Kutu	8x17x5,7		1
WL9-BX05GB	5'li Gri - Siyah Büyük Boy Boş Kutu	8x22x5,7		1
WL9-BX06GB	6'li Gri - Siyah Büyük Boy Boş Kutu	8x22x5,7		1
WL9-BX07GB	7'li Gri - Siyah Büyük Boy Boş Kutu	8x22x5,7		1
WL9-BX08GB	8'li Gri - Siyah Büyük Boy Boş Kutu	8x22x5,7		1
WL9-BXARA1	Buton Kutusu Yükseltme Aparatı	8x12,5x1,4		1
WL9-BXARA2	Buton Kutusu Yükseltme Aparatı	8x17x1,4		1
WL9-BXARA3	Buton Kutusu Yükseltme Aparatı	8x22x1,4		1
WL9-BB02G	2'li Gri - Siyah Deliksiz Küçük Boy Boş Kutu	8x12,5x5,7		1
WL9-BB04G	4'lü Gri - Siyah Deliksiz Orta Boy Boş Kutu	8x17x5,7		1
WL9-BB05G	5'li Gri - Siyah Deliksiz Büyük Boy Boş Kutu	8x22x5,7		1

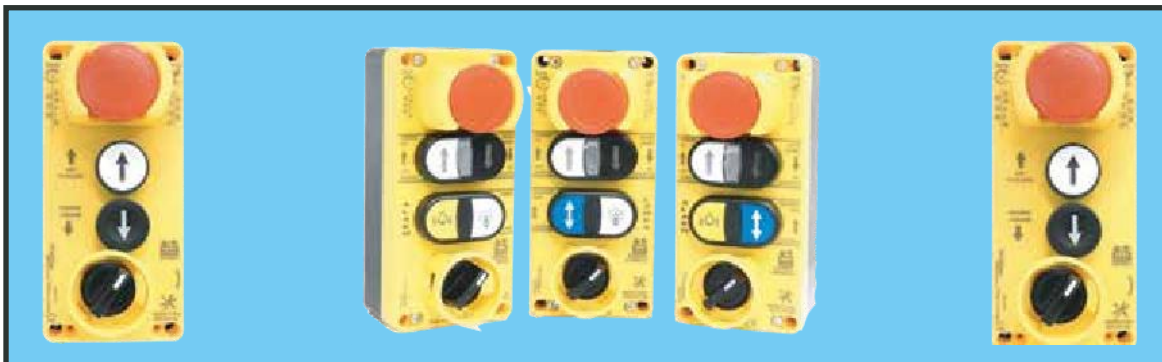

VİNÇ KUMANDA BUTONLARI

Sipariş Kodu	Cinsi	K. / AD.	
Mekanik Kilitli - Tek Hızlı			
WLK-2 (VK-2)	Tek Hızlı 2'li Vinç Kumanda Mekanik Kilitli Kontak	5 A	1
WLK-4 (VK-4)	Tek Hızlı 4'lü Vinç Kumanda Mekanik Kilitli Kontak	5 A	1
WLK-6 (VK-6)	Tek Hızlı 6'lü Vinç Kumanda Mekanik Kilitli Kontak	5 A	1



Sipariş Kodu	Cinsi	K. / AD.	
Mekanik Kilitli - Tek Hızlı - Faz Bağlantı Köprülü			
WLKB-3 (VKB-3)	Tek Hızlı 2 + Acil Stop Vinç Kumanda Mekanik Kilitli Kontak	16 A	1
WLKB-5 (VKB-5)	Tek Hızlı 4 + Acil Stop Vinç Kumanda Mekanik Kilitli Kontak	16 A	1
WLKB-7 (VKB-7)	Tek Hızlı 6 + Acil Stop Vinç Kumanda Mekanik Kilitli Kontak	16 A	1
WLKB-9 (VKB-9)	Tek Hızlı 8 + Acil Stop Vinç Kumanda Mekanik Kilitli Kontak	16 A	1



Sipariş Kodu	Cinsi	K. / AD.	
Mekanik Kilitli - Çift Hızlı			
WLK2-3 (VK2-3)	Çift Hızlı 2 + Acil Stop Vinç Kumanda Mekanik Kilitli Kontak	16 A	1
WLK2-5 (VK2-5)	Çift Hızlı 4 + Acil Stop Vinç Kumanda Mekanik Kilitli Kontak	16 A	1
WLK2-7 (VK2-7)	Çift Hızlı 6 + Acil Stop Vinç Kumanda Mekanik Kilitli Kontak	16 A	1
WLK2-9 (VK2-9)	Çift Hızlı 8 + Acil Stop Vinç Kumanda Mekanik Kilitli Kontak	16 A	1



Sipariş Kodu	Cinsi	K. / AD.	
Araç Lift Kumanda - Çift Kontaklı			
WLB-2 (KB-2)	Tek Hızlı - 2'li Lift Kumanda - Çift Kontaklı	10 A	1
WLB-3 (KB-3)	Tek Hızlı - 3'lü Lift Kumanda - Çift Kontaklı	10 A	1
WLB-4 (KB-4)	Tek Hızlı - 4'lü Lift Kumanda - Çift Kontaklı	10 A	1
WLBM-2 (KB-2)	Tek Hızlı - 2'li Lift Kumanda - Mıknatıslı	10 A	1
WLBM-3 (KB-3)	Tek Hızlı - 3'lü Lift Kumanda - Mıknatıslı	10 A	1
WLBM-4 (KB-4)	Tek Hızlı - 4'lü Lift Kumanda - Mıknatıslı	10 A	1



KOD	Cinsi	K. / AD.	
Vinç Butonu Yedek Kontak			
MN-VK2	Anahtarlı Monofaze Vinç Kumanda Kondansatör Kutulu (İçinde Kondansatör Bulunmamaktadır)	1	



LİMİT SWITCHLER



Özellikler:

- Estetik plastik gövde, yüksek mekanik dayanıklılık
- Ekstra geniş $\pm 95^\circ$ hareketli kompakt gövde
- 1NO / 1NC 2 anahtarlamalı kontak
- Hareketli çift kontaklar
- PG 13.5 / M20 x 1.5 kablo rakoru girişli
- IP 67
- Kapak içi lastik conta
- Tüm modellerde tahrik kafa contası
- Gövde vidası M3 + somun sıkmalı
- Kontak bloğunu çıkartarak dışarda rahat bağlantı olanağı
- Uluslararası gövde standartlarında



Üst kapak vidası M3 kapaktan düşmez. Kontak bloğu çıkarılabilir, rahatlıkla kablo bağlanır.

Yanmaz - Kırılmaz özel plastik gövde. Kollu ürünlerde $5^\circ - 90^\circ$ hassas ayar olanağı, uzun kol mesafesi.

XCK PLASTİK GÖVDELİ LİMİT SWITCH

Sipariş Kodu	Cinsi	Kontak	K. / AD.
XCK-SUM 211 (CLS101)	Doğrusal Hareketli Metal Pim	1NO+1NC	10
XCK-SUM 211A (CLS 101S)	Doğrusal Hareketli Uzun Metal Pim	1NO+1NC	10
XCK-SUM 331 (CLS 103)	Doğrusal Hareketli 11mm Metal Makaralı Pim	1NO+1NC	10
XCK-SUM 332R (CLS103R)	Doğrusal Hareketli Resetli 11mm Metal Pim	1NO+1NC	10
XCK-SİM 311 (CLS 111)	Açısal Hareketli 14mm Metal Makaralı Kol	1NO+1NC	10
XCK-SİM 411 (CLS127)	Açısal Hareketli Ters Açılı 14 mm Metal Makaralı Kol	1NO+1NC	10
XCK-SEM 121 (CLS121)	Açısal Hareketli 18 mm Metal Makaralı Döner Kol	1NO+1NC	10
XCK-SEM 122 (CLS131)	Açısal Hareketli Ayarlanabilir 18 mm Metal Makaralı Döner Kol	1NO+1NC	10
XCK-SEM 124 (CLS103)	Açısal Hareketli Ayarlanabilir 18 mm Metal Makaralı Döner Kıvrık Kol	1NO+1NC	10
XCK-SEM 123	Açısal Hareketli Ayarlanabilir 18 mm Metal Makaralı Döner Uzun Kol	1NO+1NC	10
XCK-SEL 123 (CLS191)	Açısal Hareketli Ayarlanabilir 50 mm Lastik Makaralı Döner Uzun Kol	1NO+1NC	10
XCK-SEL 123R	Açısal Hareketli Ayarlanabilir 50 mm Lastik Makaralı Döner Uzun Kol Resetli	1NO+1NC	10
XCK-SOM 101 (CLS161)	Açısal Hareketli Spiral Telli Çok Yönlü Kol	1NO+1NC	10
XCK-SOM 102	Açısal Hareketli Metal Uçlu Metal Spiral Çok Yönlü Kol	1NO+1NC	10
XCK-SOP 101 (CLS171)	Açısal Hareketli Plastik Uçlu Metal Spiral Çok Yönlü Kol	1NO+1NC	10
XCK-SOP 102	Açısal Hareketli Plastik Uçlu Metal Spiral Çok Yönlü Kol	1NO+1NC	10
XCK-SOP 103	Açısal Hareketli Metal Spiral Çok Yönlü Kol	1NO+1NC	10
XCK-REM 121	Açısal Hareketli Ayarlanabilir 130 mm Metal Çubuk Kol	1NO+1NC	10

LİMİT SWITCHLER



MIKROSWİTCH (Silver Contact) (15 Amper)

Doğru kullanımda 1.000.000 Aç/Kapa

Sipariş Kodu	Cinsi	Kontak	K. / AD.
XV-15-1C25	Buton Tip Pimli	1NO+1NC	100
XV-151-1C25	Kısa Palet	1NO+1NC	100
XV-152-1C25	Orta Palet	1NO+1NC	100
XV-153-1C25	Uzun Palet	1NO+1NC	100
XV-154-1C25	Çengel Palet	1NO+1NC	100
XV-155-1C25	Kısa Palet Pls. Makaralı	1NO+1NC	100
XV-156-1C25	Uzun Palet Pls. Makaralı	1NO+1NC	100
DS438	Dikey Tahrikli	1NO+1NC	100

MİNİ SWİTCHLER



MINISWİTCH (Silver Contact)

Doğru kullanımda 1.000.000 Aç/Kapa

Sipariş Kodu	Cinsi	Kontak	K. / AD.
XZ-15GD-B (CM1306)	Kalın Kısa Pimli	1NO+1NC	20
XZ-15GQ-B (CM1307)	Kalın Uzun Pimli	1NO+1NC	20
XZ-15GQ22-B (CM1308)	Yatay Metal Makaralı Pim	1NO+1NC	20
XZ-15GQ21-B (CM1309)	Dikey Metal Makaralı Pim	1NO+1NC	20
XZ-15GW-B (CM1701)	Uzun Palet	1NO+1NC	20
XZ-15GW2277-B (CM1743)	Kısa Metal Makara Tahrikli	1NO+1NC	20
XZ-15GW22-B (CM1704)	Kısa Palet Metal Makaralı	1NO+1NC	20
XZ-15GW23-B	Orta Palet Metal Makaralı	1NO+1NC	20
XZ-15GW2-B (CM1703)	Uzun Palet Metal Makaralı	1NO+1NC	20
XZ-15HW24-B (CM1705)	Uzun Tel Palet	1NO+1NC	20
XAP-Y	Mini Switch Koruma Kılıfı 45° Açılı Kauçuk		50
XZP-Y	Mini Switch Koruma Kılıfı Düz Plastik		100

METAL VE PLASTİK LED'Lİ SİNYAL



Sipariş Kodu	Renk	Cinsi	K. / AD.
Ø 8 mm Metal Led'li Sinyal			
WL8-71-24	○	Ø 8 mm Metal Kablolu Sinyal 12 / 24 V AC/DC	50
WL8-73-24	●	Ø 8 mm Metal Kablolu Sinyal 12 / 24 V AC/DC	50
WL8-74-24	●	Ø 8 mm Metal Kablolu Sinyal 12 / 24 V AC/DC	50
WL8-75-24	●	Ø 8 mm Metal Kablolu Sinyal 12 / 24 V AC/DC	50
WL8-76-24	●	Ø 8 mm Metal Kablolu Sinyal 12 / 24 V AC/DC	50
Ø 14 mm Plastik Led'li Sinyal			
WL14-73-24	●	Ø14mm Plastik Kablolu Sinyal 12 / 24 V AC/DC	50
WL14-74-24	●	Ø14mm Plastik Kablolu Sinyal 12 / 24 V AC/DC	50
WL14-75-24	●	Ø14mm Plastik Kablolu Sinyal 12 / 24 V AC/DC	50

SARF ÜRÜNLERİ



Sipariş Kodu	Cinsi	K. / AD.
Potansiyometreler / Metal Dial Düğmeler		
PT-11	Tek Turlu Potansiyometre 2W (5K/10K/20K)	10
PT-42	Çok Turlu Potansiyometre 2W (5K/10K/20K/50K/100K)	10
PT-92	Çok Turlu Counter Metal Dial Küçük	10
PT-94	Çok Turlu Counter Metal Dial Büyük	10
Köprü Diyot		
KD-35	35 Amp. Köprü Diyot	50
KD-50	50 Amp. Köprü Diyot	50

AYAK PEDALLARI



Sipariş Kodu	Cinsi	Kontakt	K. / AD.
AP-1	1.5 Mt. Kablolu Metal Pedal	1NO+1NC	1
AP-2	1.5 Mt. Kablolu Döküm Pedal	1NO+1NC	1
AP-3	1.5 Mt. Kablolu Döküm Pedal	1NO+1NC	1
AP-9	Döküm Korumalı Kapaklı Pedal	1NO+1NC	1
F15M	Döküm Pedal Yarım Korumalı	1NO+1NC	1